

ABRIS EN KIT

OPEN & SAFE







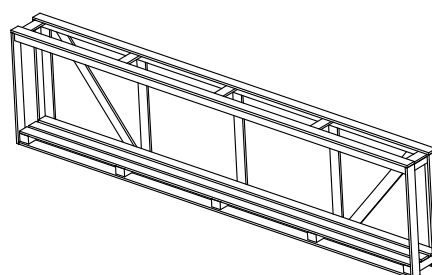
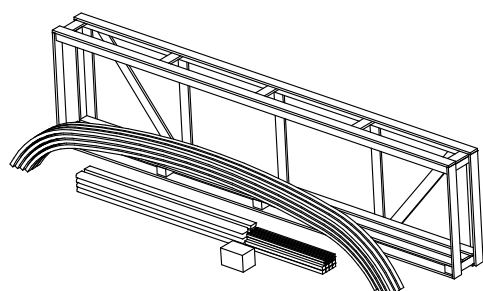
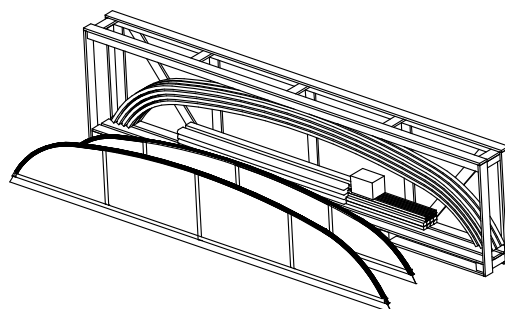
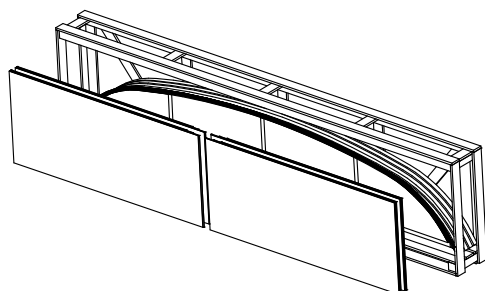
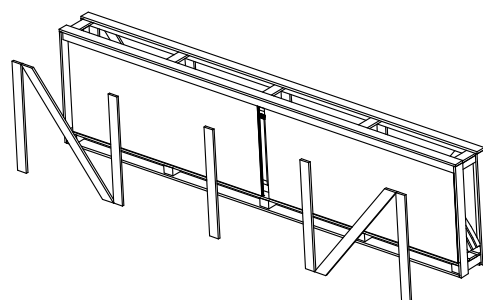
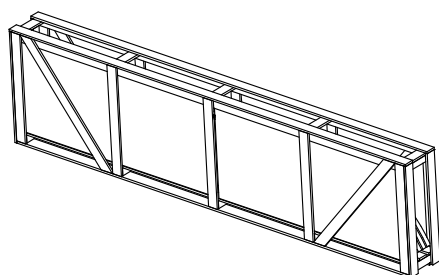
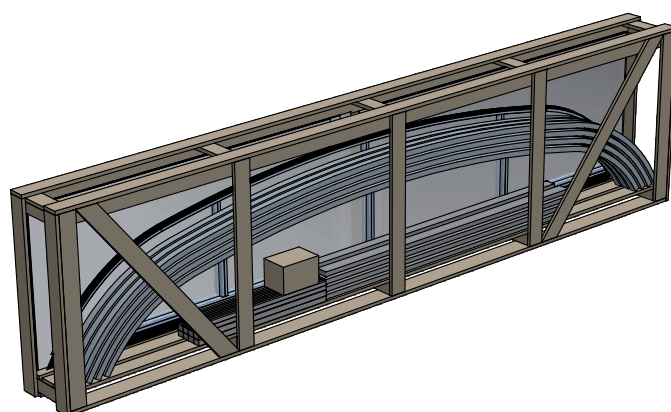







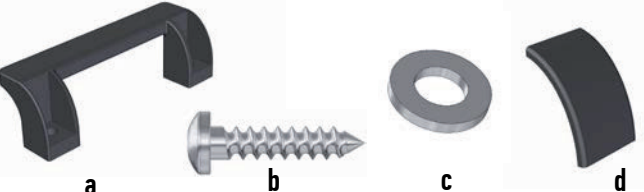
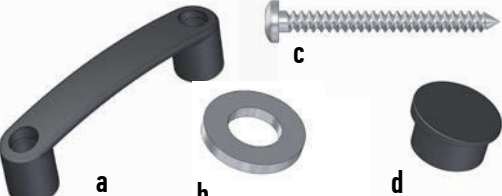

NOTICE DE MONTAGE

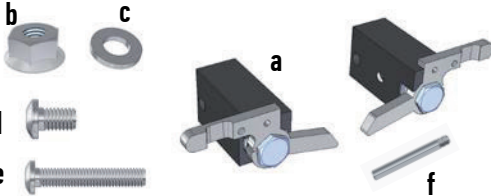



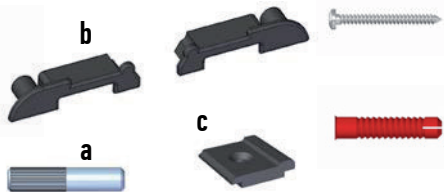
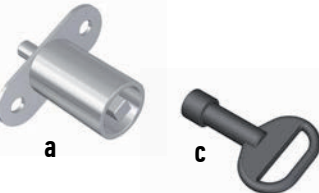

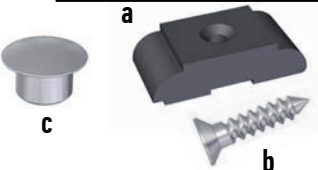
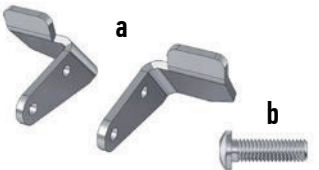
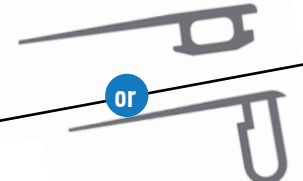
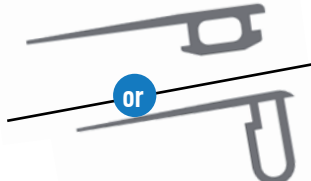
DÉMONTAGE DE LA CAISSE

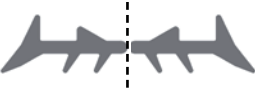
Modèle	Dimensions extérieures			Poids
	largeur	hauteur	profondeur	kg
C-11-210436 6x3 A3	4750	1350	410	245
C-11-210437 7x3 A3/4	4750	1350	410	320
C-11-210438 8x4 A4	5950	1350	410	400
C-11-210439 10x4 A4/5	5950	1350	410	475
C-11-210440 10x5 A5	6550	1350	500	590

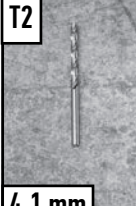
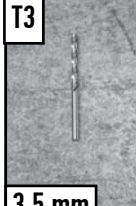
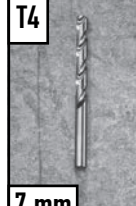

LISTE DES ACCESSOIRES

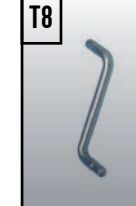
<p>1</p> <p>Vis 4,8x50</p> 	<p>2</p> <p>Butée d'arrêt avec vis 4,2x10</p> 	<p>3</p> <p>Rivet POP 12 mm</p> 	<p>4</p> <p>Serrure</p> 
<p>5</p> <p>Vis 6x60</p> 	<p>6</p> <p>Cheville</p> 	<p>7</p> <p>Poignée intérieure</p> 	
<p>8</p> <p>Poignée extérieure</p> 	<p>9</p> <p>Caches de finition sans verrouillage D-G</p> 	<p>10</p> <p>Verrouillage dissimé</p> 	
<p>11</p> <p>Cache de finition (coté joint)</p> 	<p>12</p> <p>Verrouillage avec bec</p> 	<p>13</p> <p>Douille-verrou</p> 	<p>14</p> <p>Jonctions de platines + butées platine + embout sécurité</p> 
<p>15</p> <p>Serrure porte coulissante + bouchon</p> 	<p>16</p> <p>Molette de fixation facade/fond</p> 	<p>17</p> <p>Butée + bouchon porte latérale + vis</p> 	<p>18</p> <p>Plaques de déviation avec vis</p> 
<p>19</p> <p>Joint porte latérale</p> 	<p>20</p> <p>Joint entre les éléments</p> 	<p>21</p> <p>Joint bas porte coulissante</p> 	<p>22</p> <p>Joint extérieur seulement</p>  <p>*Pour remplissage PC plein</p>

<p>T1</p> 	<p>T2</p>  <p>4.1 mm</p>	<p>T3</p>  <p>3.5 mm</p>	<p>T4</p>  <p>7 mm</p>	<p>T5</p>  <p>TRX 25</p>	<p>T6</p>  <p>TRX 20</p>	<p>T7</p> 	<p>T8</p> 	<p>T9</p> 
--	---	---	---	---	--	---	---	---

1 DÉMONTAGE DE LA CAISSE

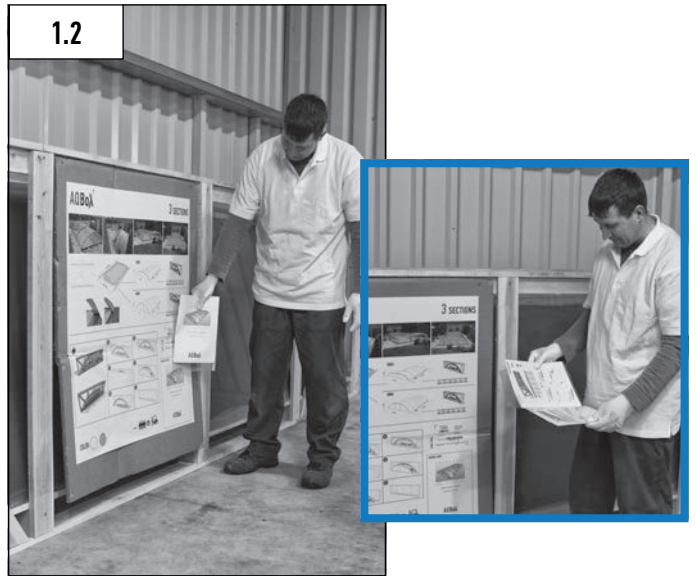

1 DÉMONTAGE DE LA CAISSE

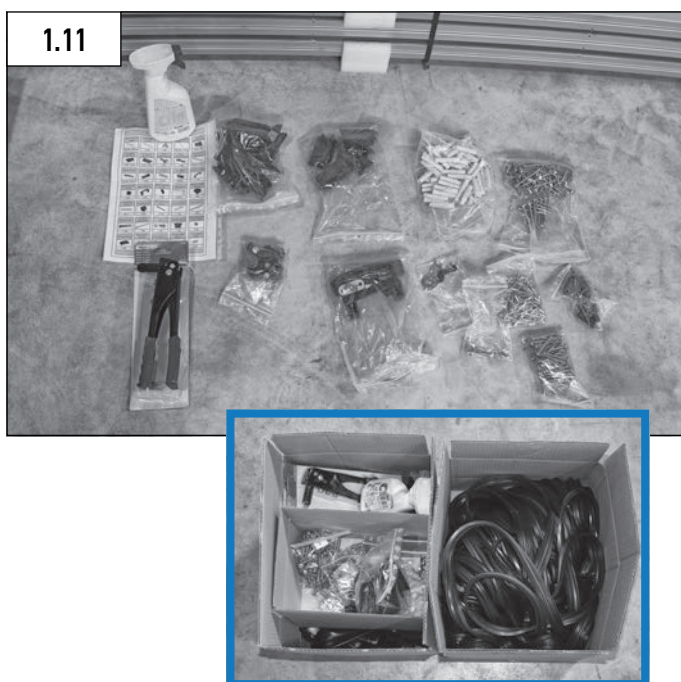
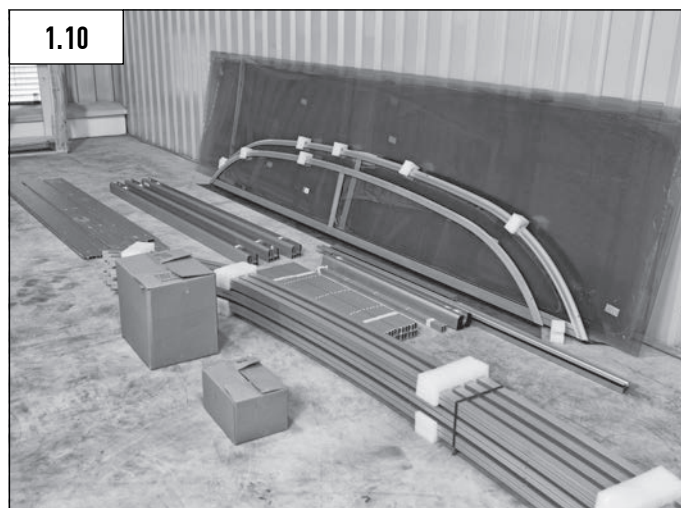
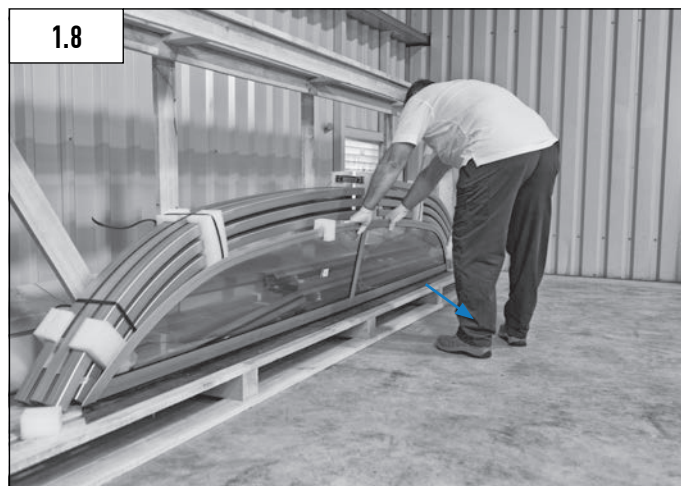

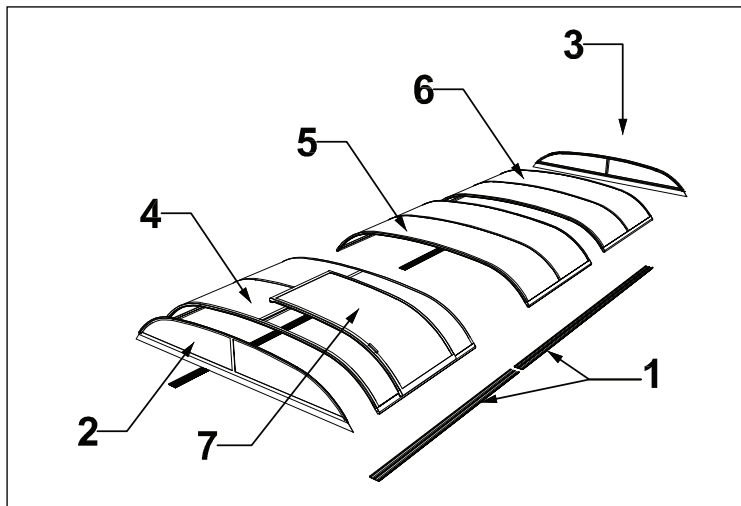

SPÉCIFICATION DE L'ABRI A3			
no.	dénomination	pcs	chapi- tre
1	platine	4	2
2	façade	1	8
3	fond	1	8
4	élément no. 1	1	3
5	élément no. 2	1	4
6	élément no. 3	1	4
7	porte lat. coulissante	1	6

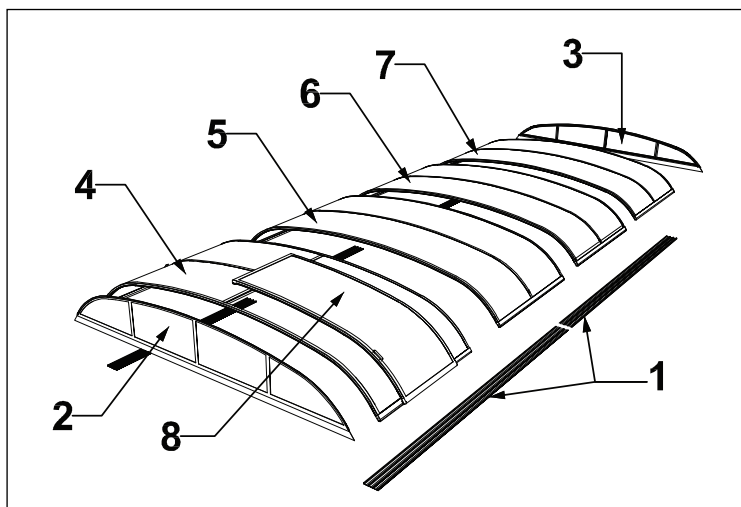

SPÉCIFICATION DE L'ABRI A3/4, A4S, A4L*, A4				
Nr.	Item name	Pcs	Pcs	Chapter
1	platine	4	6* (A4L)	2
2	façade	1	1	8
3	fond	1	1	8
4	élément no. 1	1	1	3
5	élément no. 2	1	1	4
6	élément no. 3	1	1	4
7	élément no. 4	1	1	4
8	Porte latérale coulissante	1	1	6

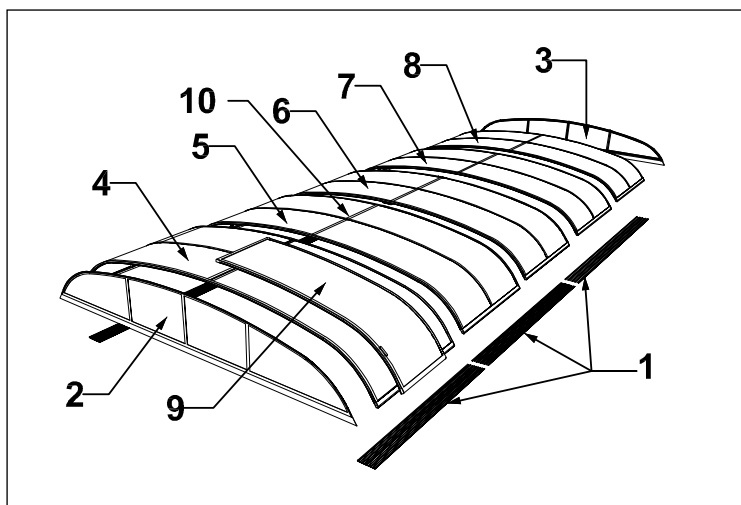

SPÉCIFICATION DE L'ABRI A4/5, A5				
no.	dénomination	no. article	pcs	chapitre
1	platine	6	2	2
2	façade	1	8	2
3	fond	1	8	2
4	élément no. 1	1	3	2
5	élément no. 2	1	4	8
6	élément no. 3	1	4	8
7	élément no. 4	1	4	3
8	élément no. 5	1	4	4
9	Porte latérale coulissante	1	6	4
10	Profilé G	10	3	4

Emplacement des platines

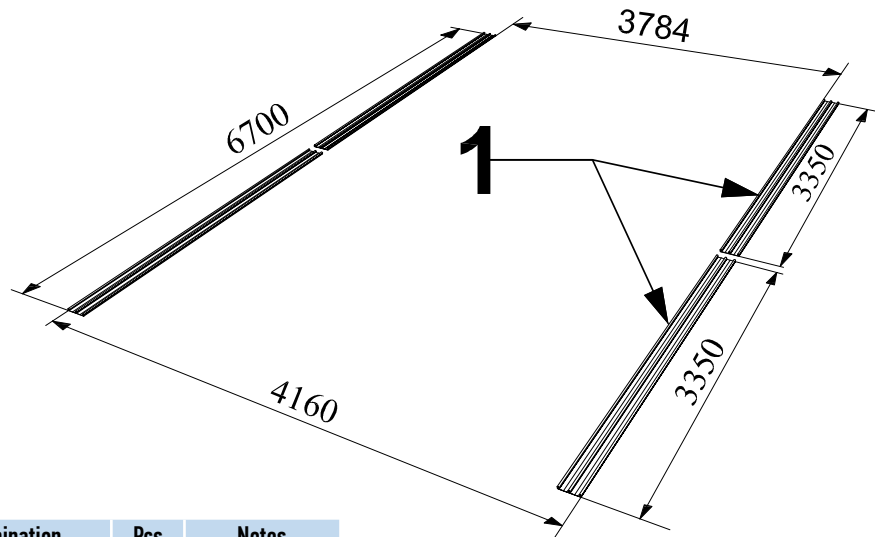

No. article	Dénomination	Pcs	Notes
1	Platine	4	3350 mm
5	Vis tête plate	40	6x60
6	cheville	40	
14a	jonction platine	6	

Les points de perçages sur les platines recommandés (dépendant du sol)

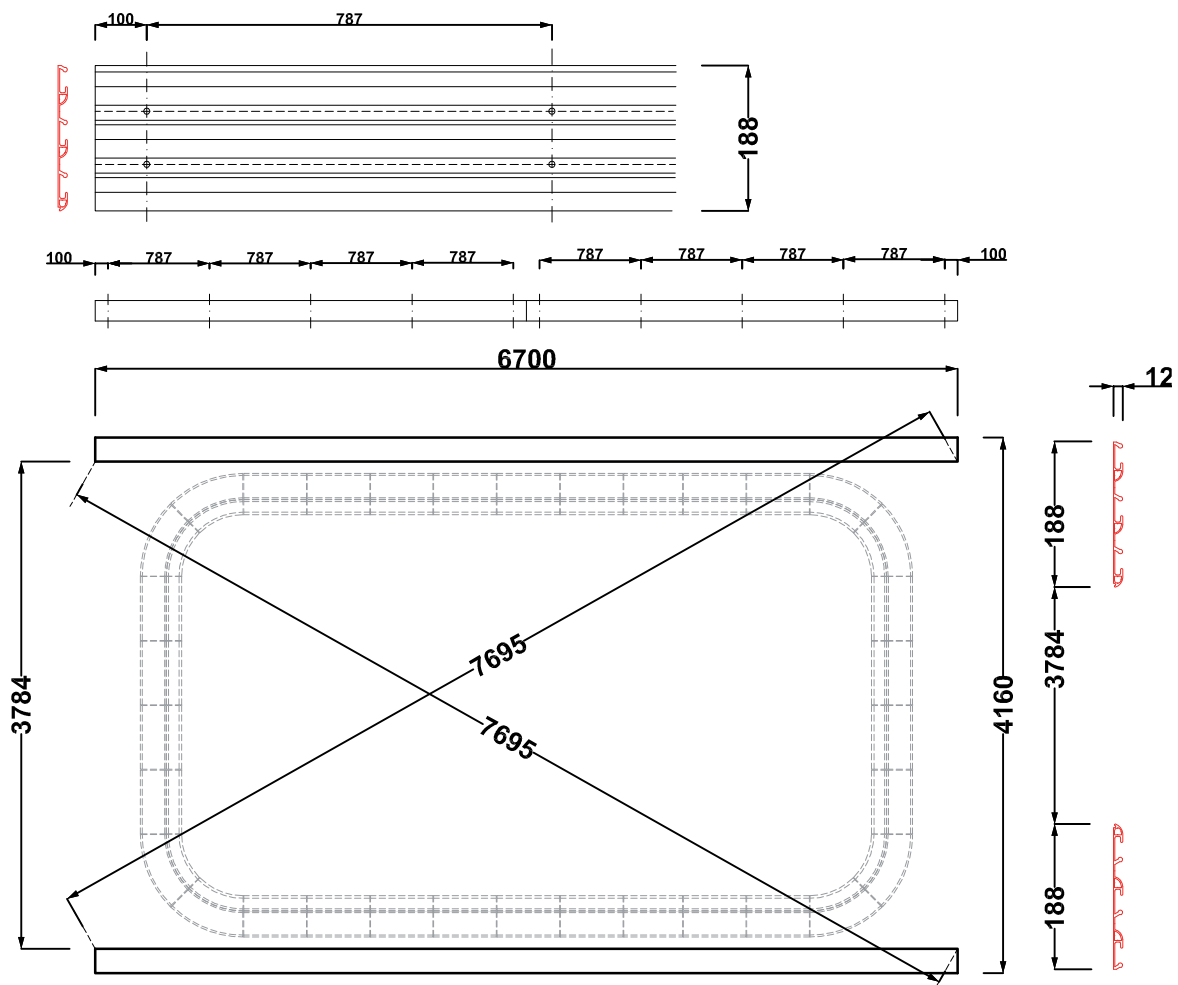

Emplacement des platines

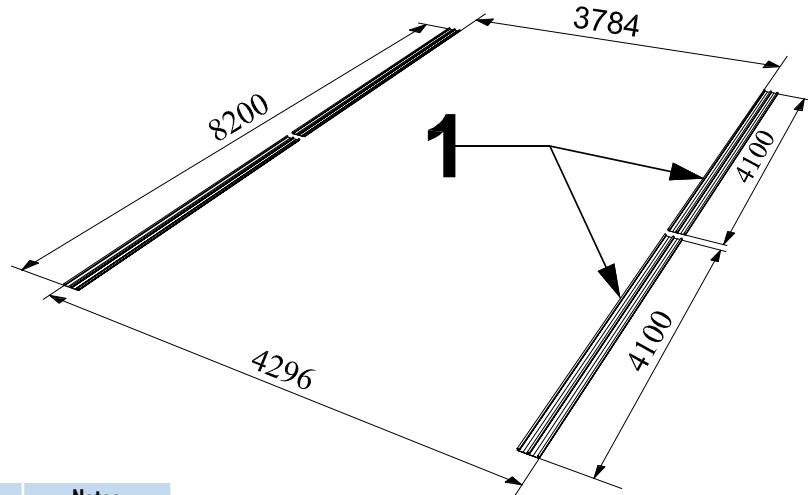

No. article	Dénomination	Pcs	Notes
1	Platine	4	4100mm
5	Vis tête plate	60	6x60
6	cheville	60	
14a	jonction platine	8	

Les points de perçages sur les platines recommandés (dépendant du sol)

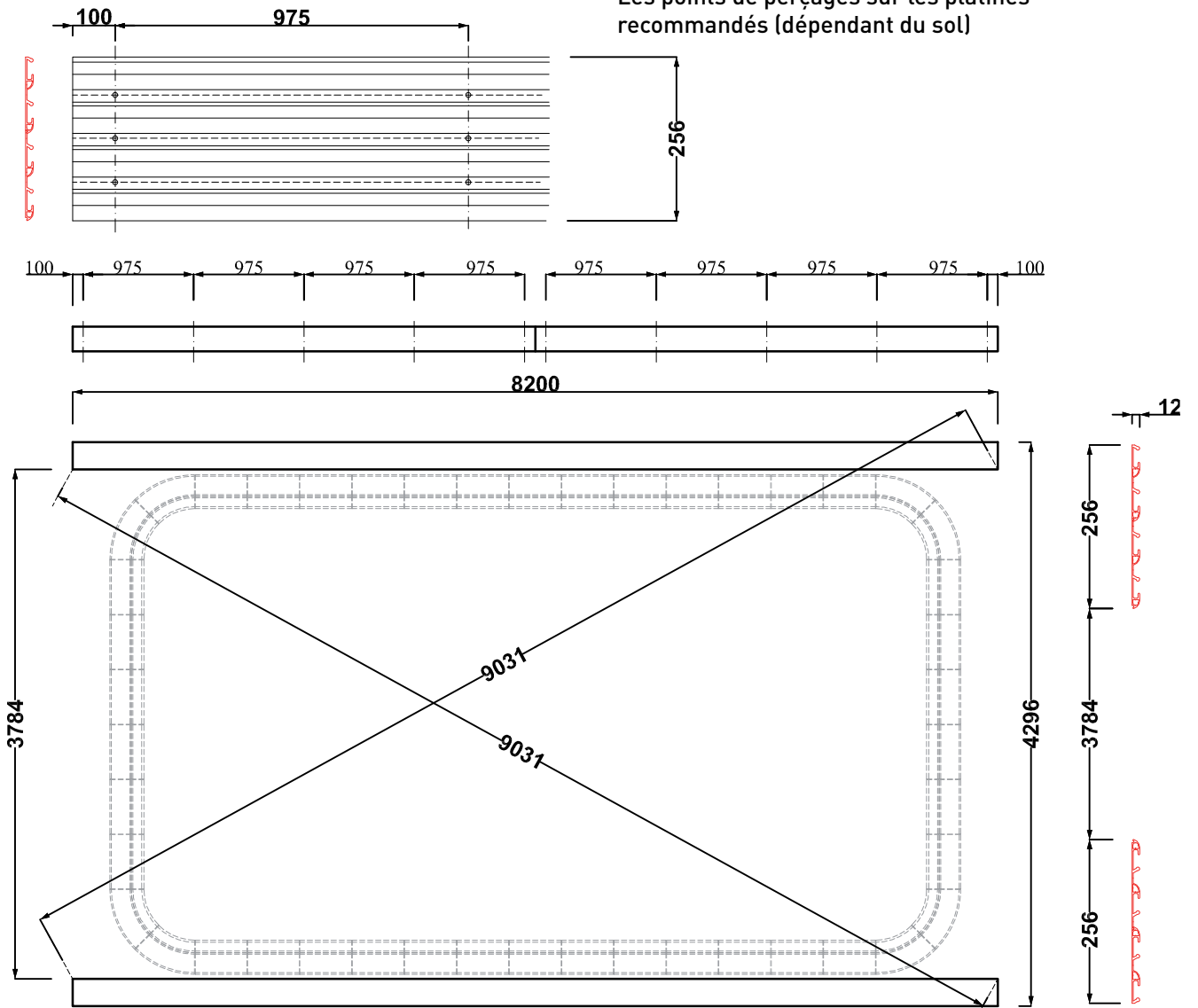

Emplacement des platines

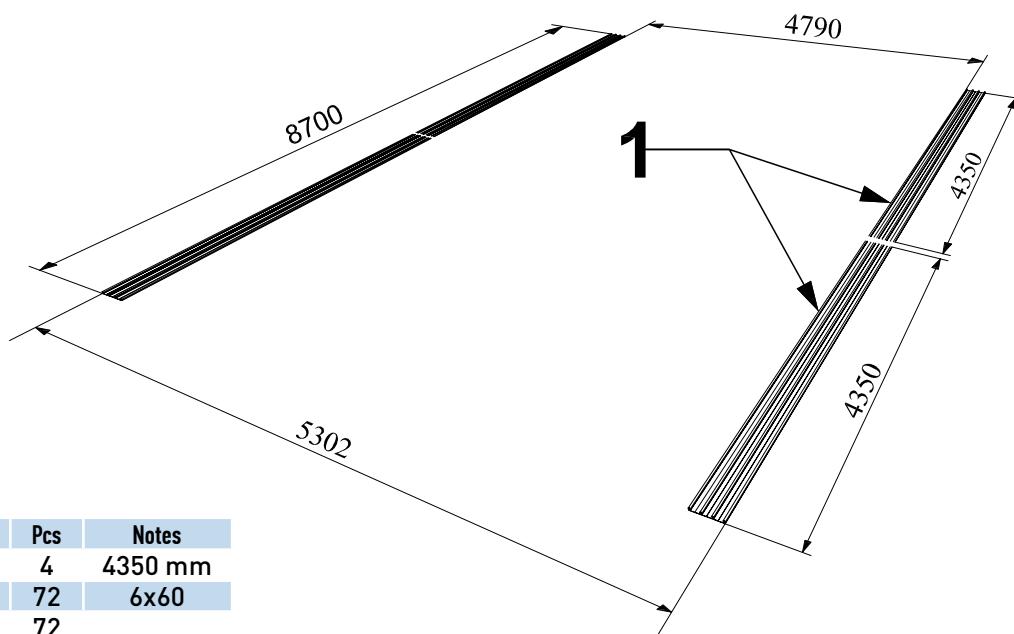

No. article	Dénomination	Pcs	Notes
1	Platine	4	4350 mm
5	Vis tête plate	72	6x60
6	cheville	72	
14a	jonction platine	8	

Les points de perçages sur les platines recommandés (dépendant du sol)

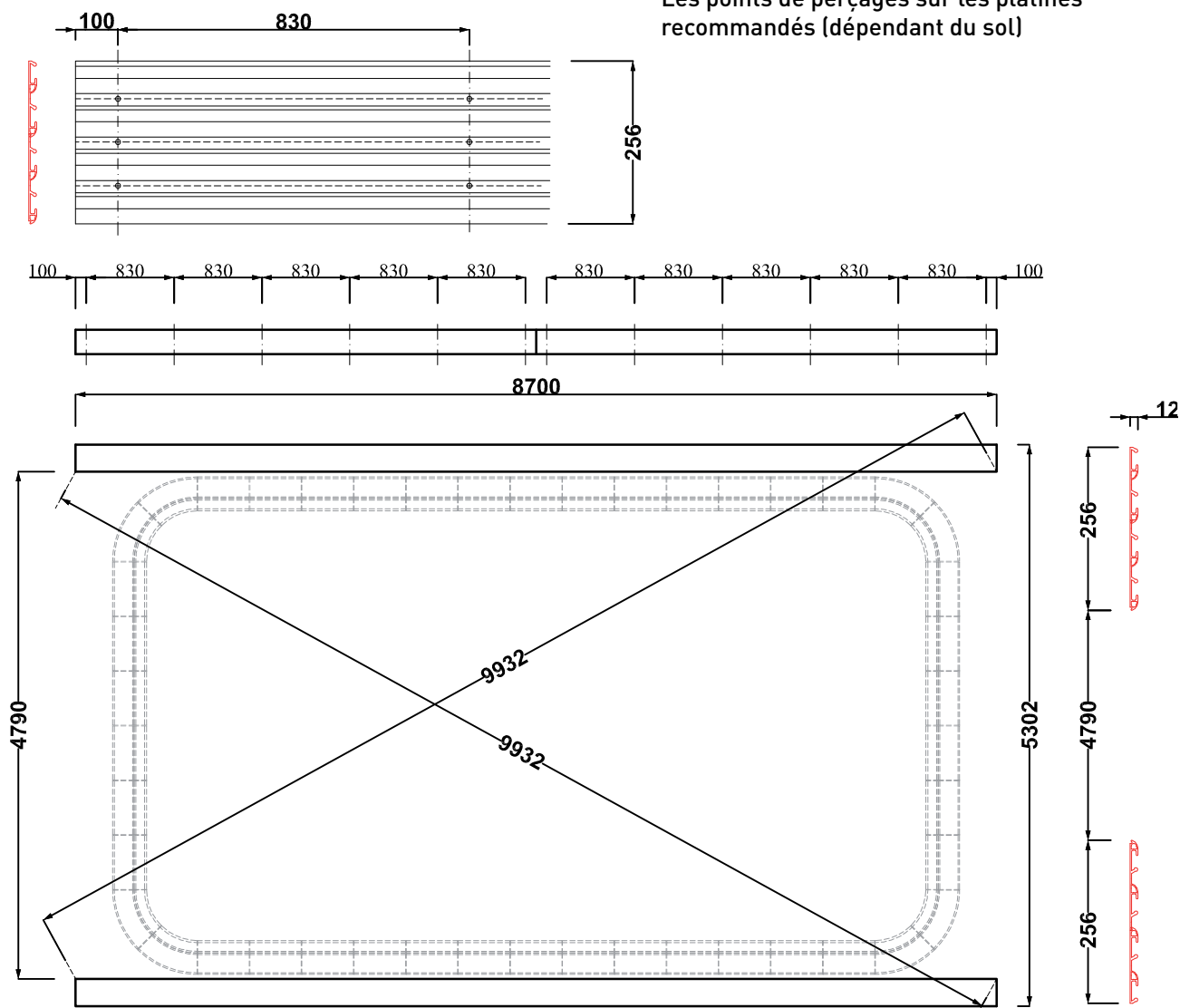

Emplacement des platines

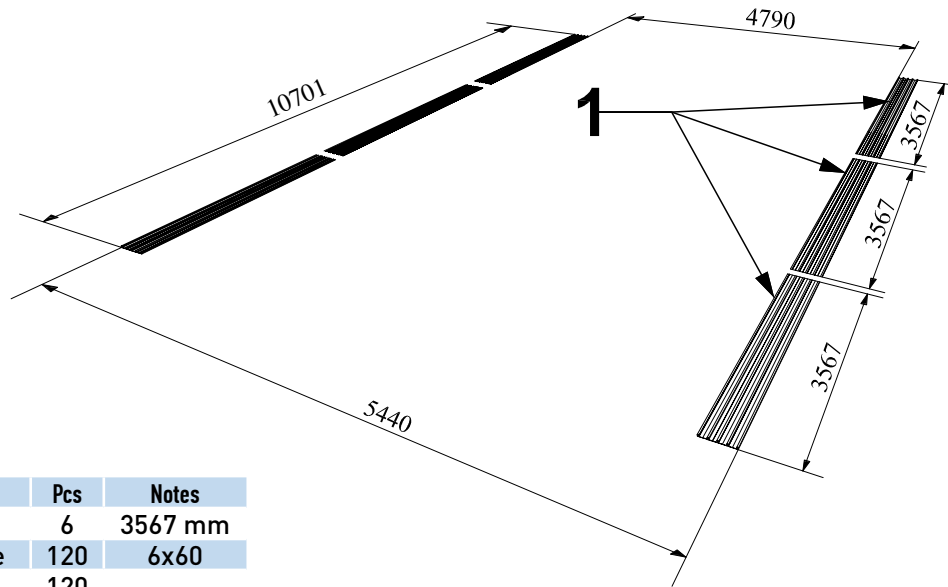

No. article	Dénomination	Pcs	Notes
1	Platine	6	3567 mm
5	Vis tête plate	120	6x60
6	cheville	120	
14a	jonction platine	20	

Les points de perçages sur les platines recommandés (dépendant du sol)

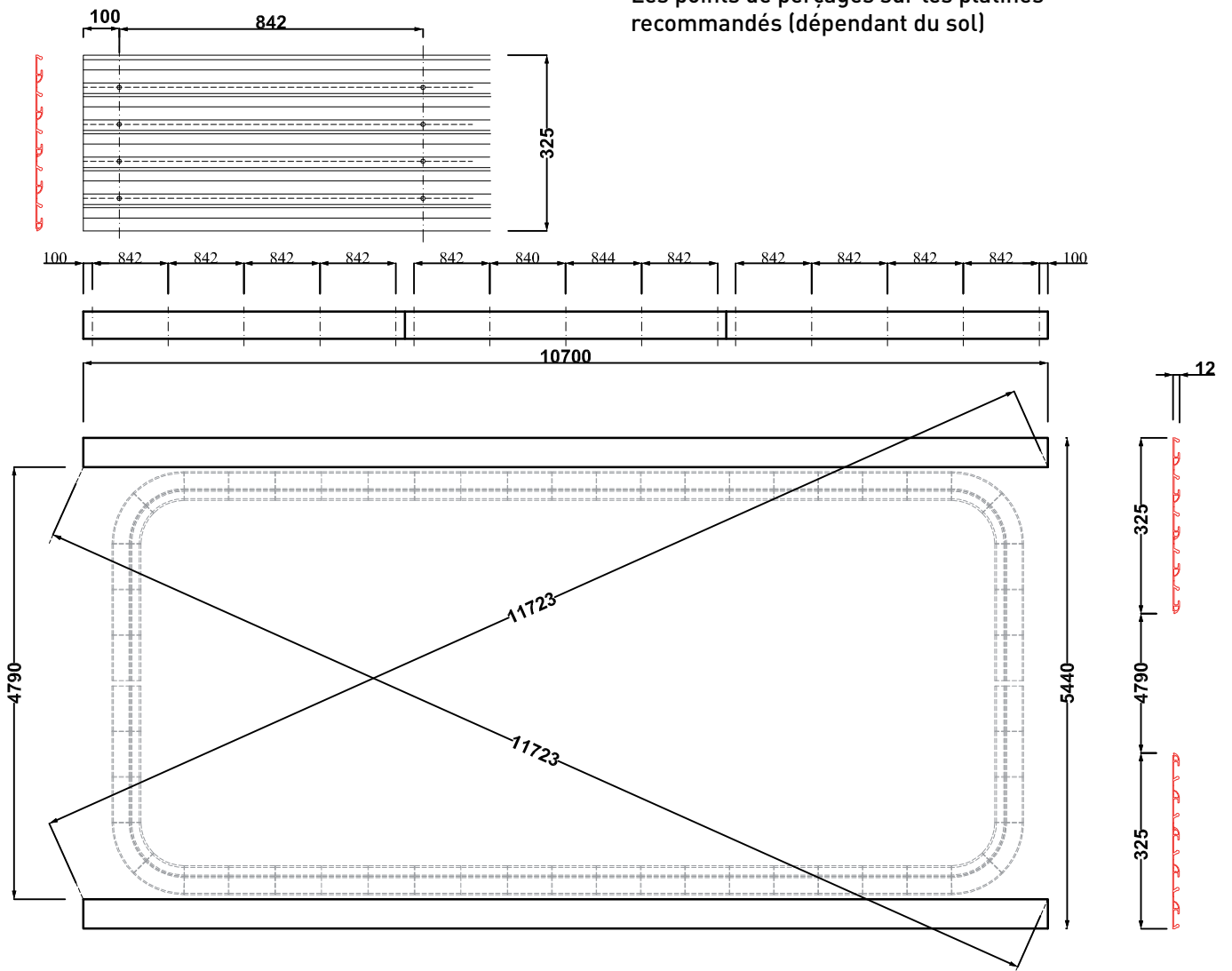

Emplacement des platines

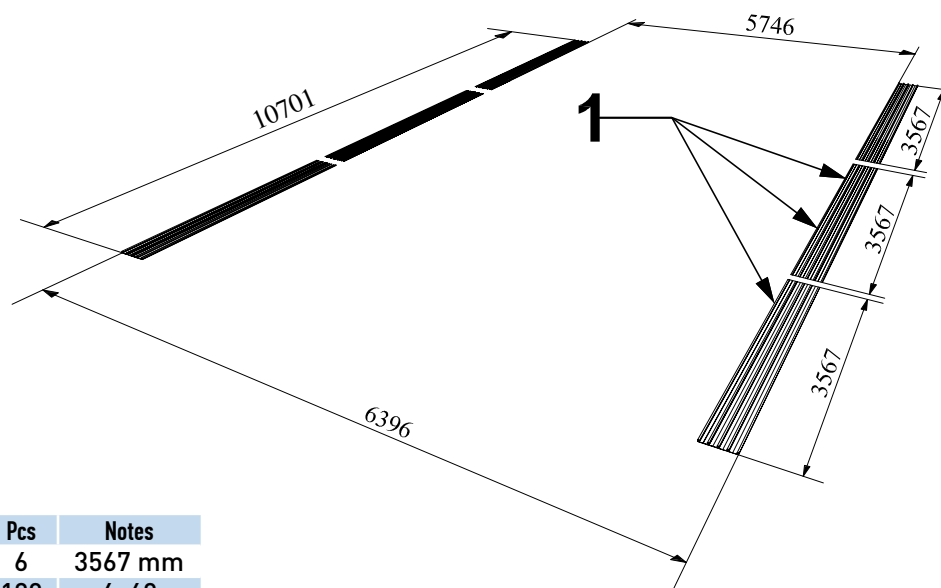

No. article	Dénomination	Pcs	Notes
1	Platine	6	3567 mm
5	Vis tête plate	120	6x60
6	cheville	120	
14a	jonction platine	20	

Les points de perçages sur les platines recommandés (dépendant du sol)

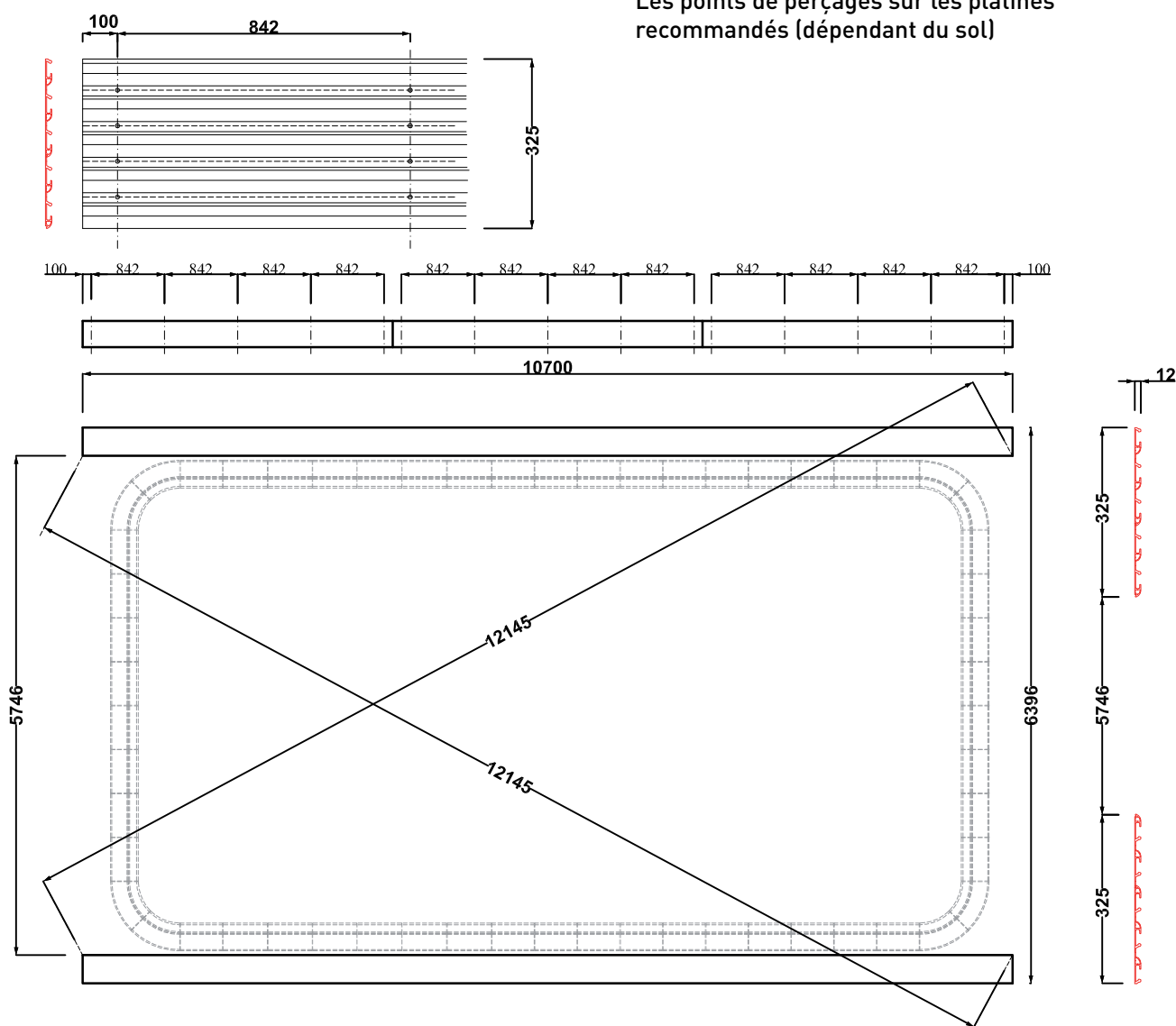

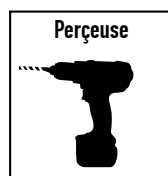
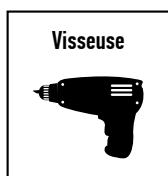
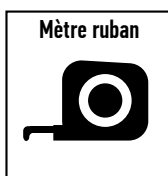
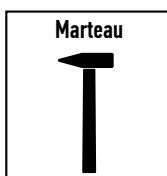
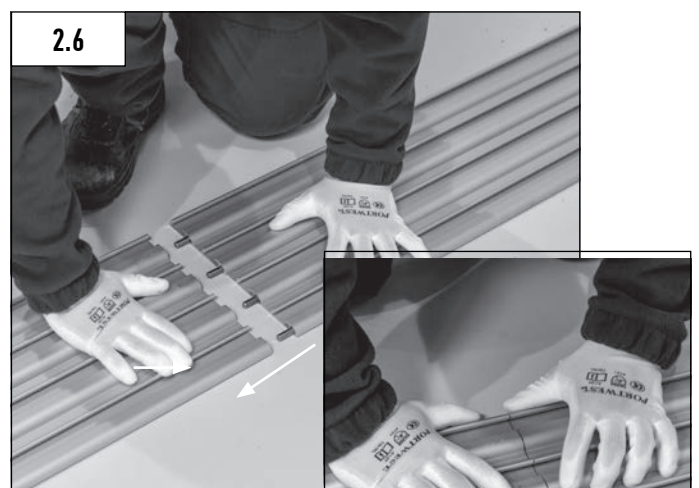
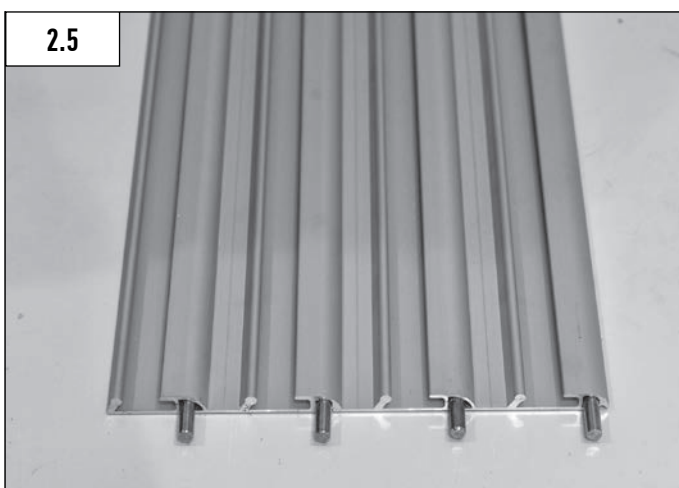
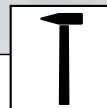
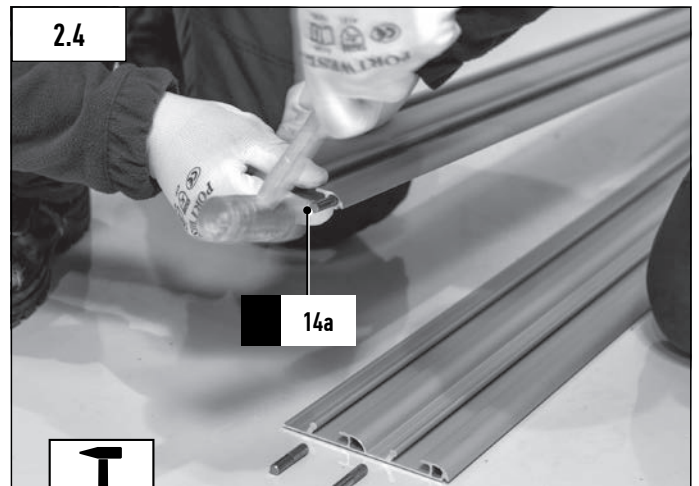

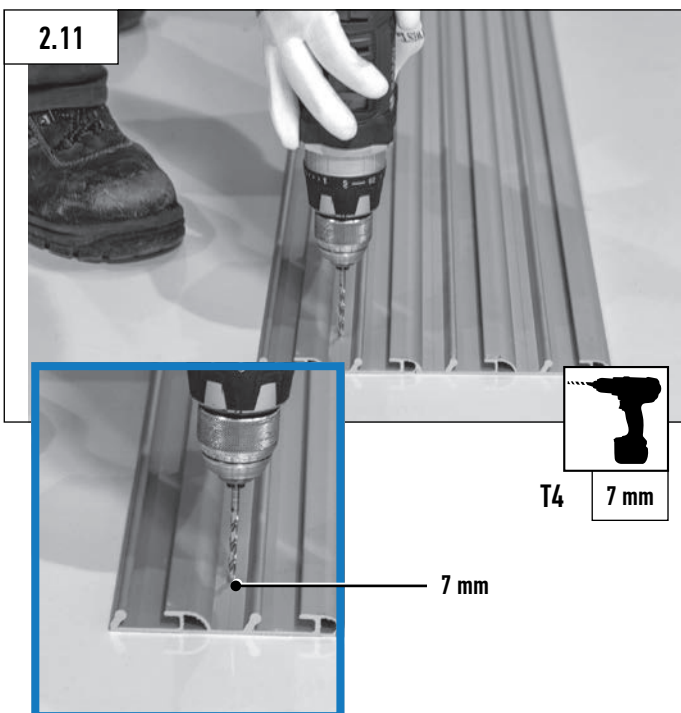
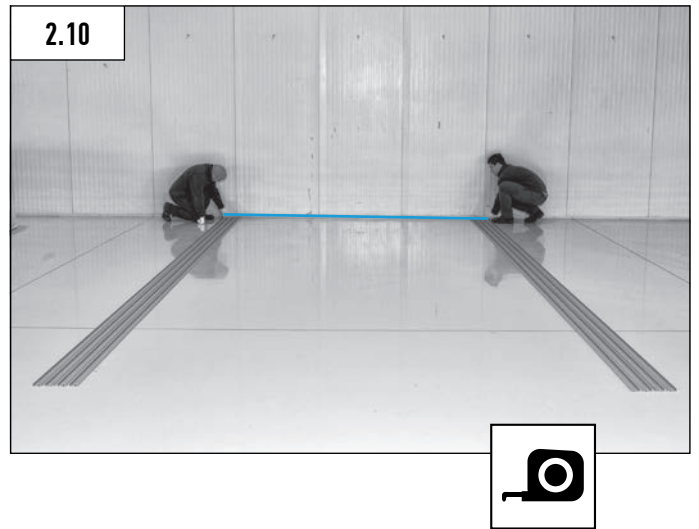
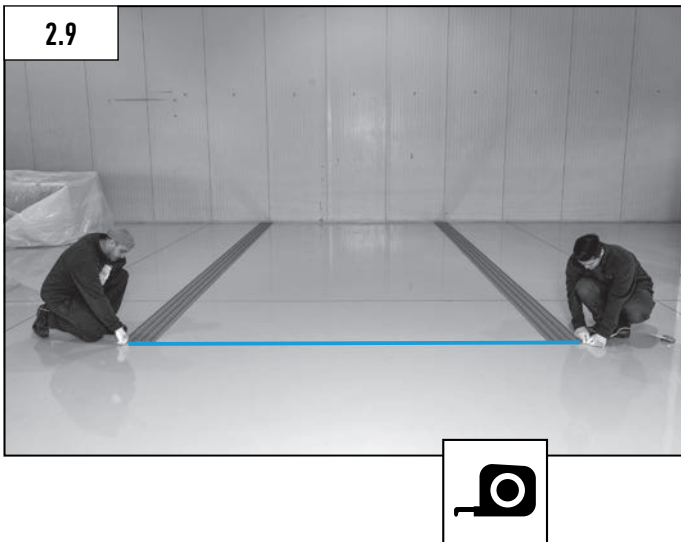
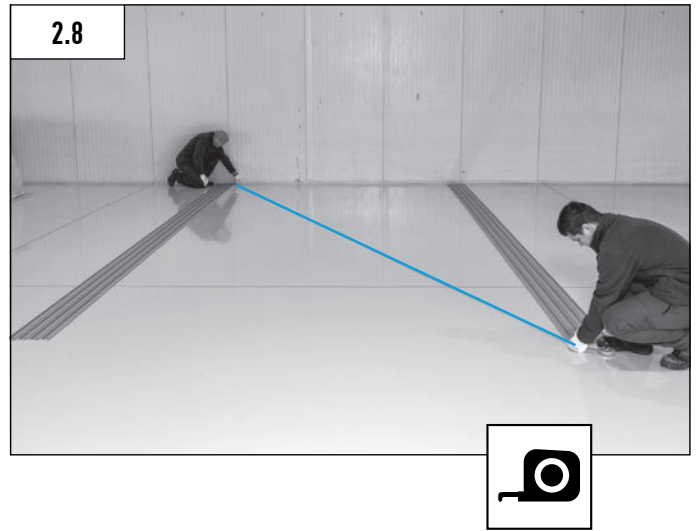

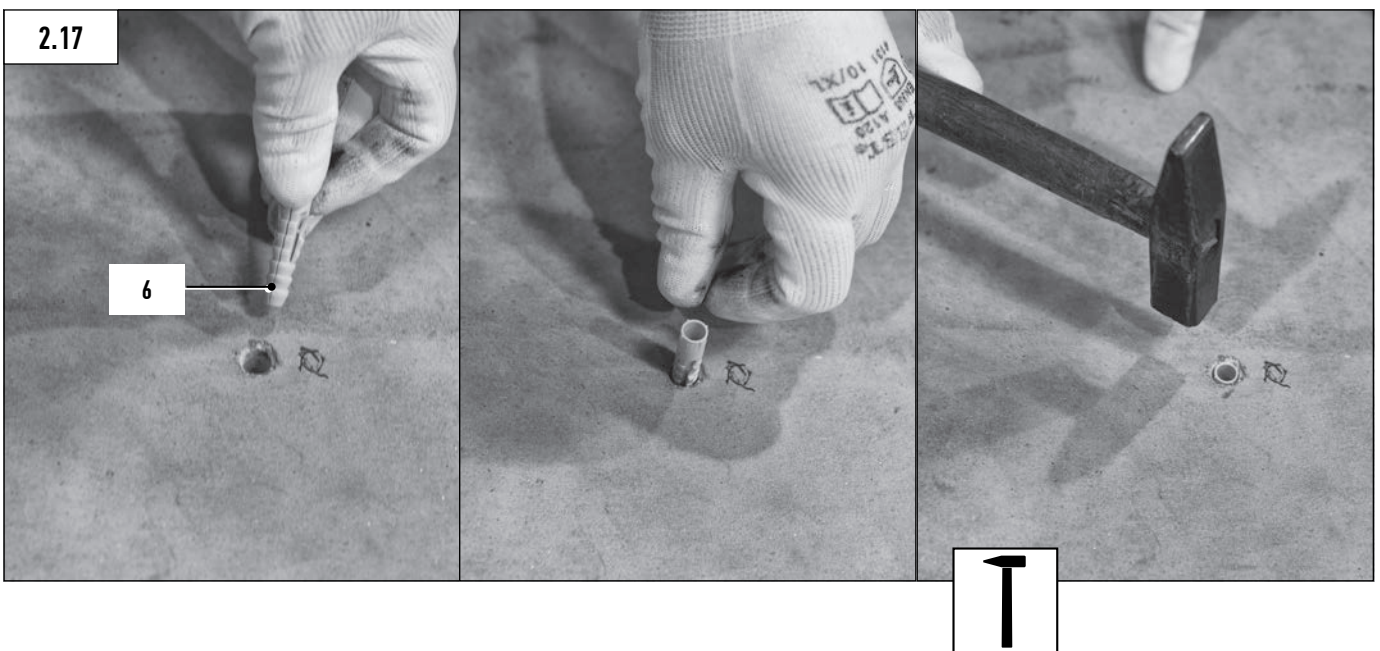
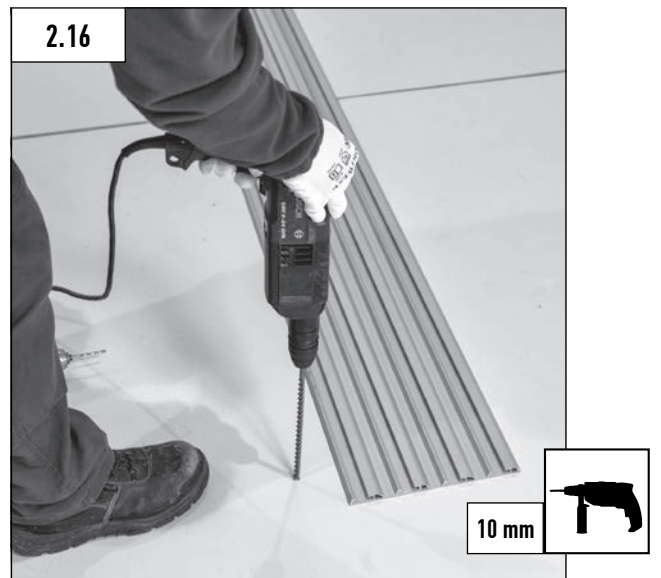
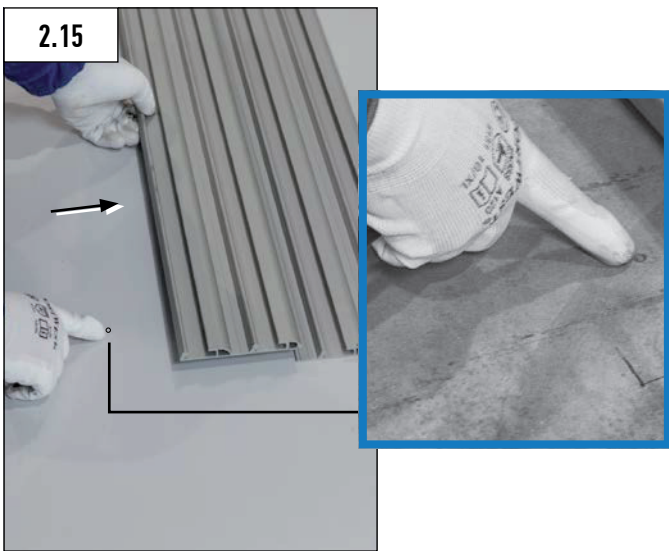
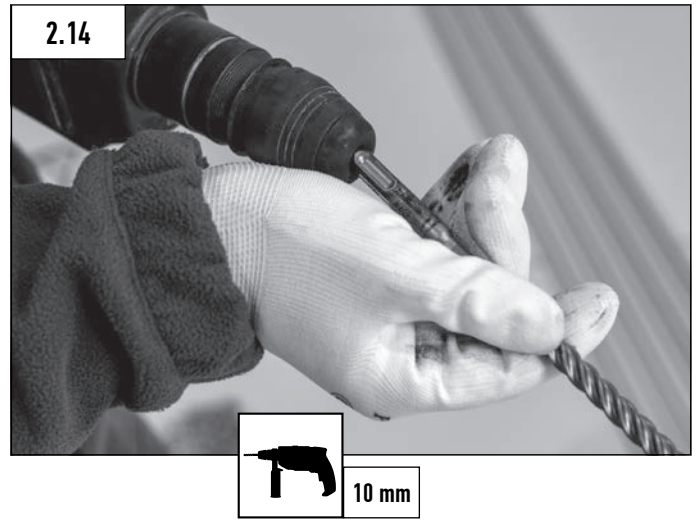
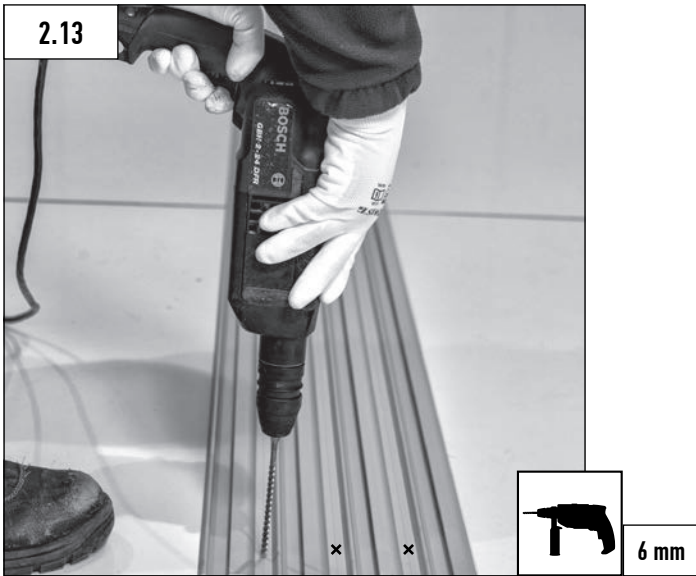

2 MONTAGE DES PLATINES GAA.

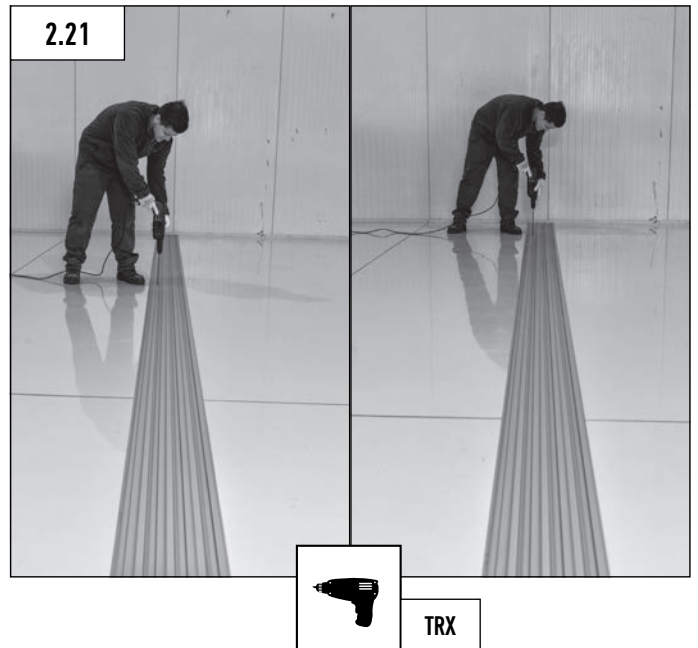
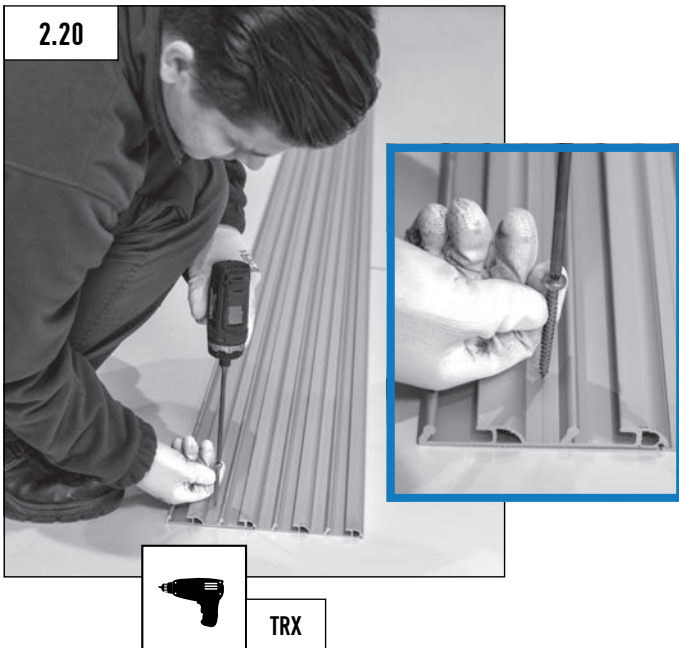
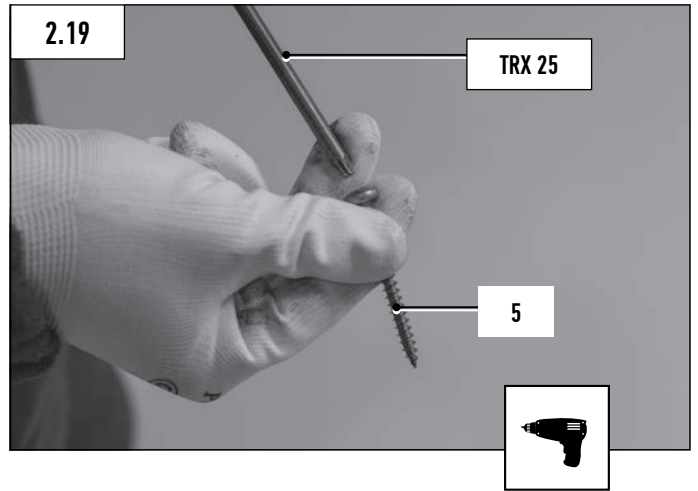

3 ASSEMBLAGE DU 1ER ÉLÉMENT

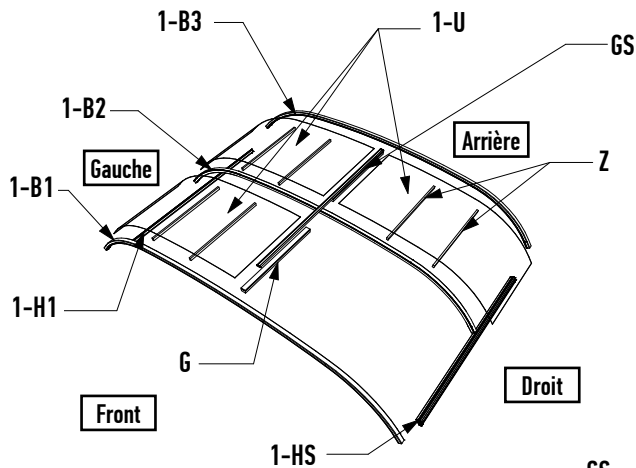

avec une porte coulissante sur le côté droit

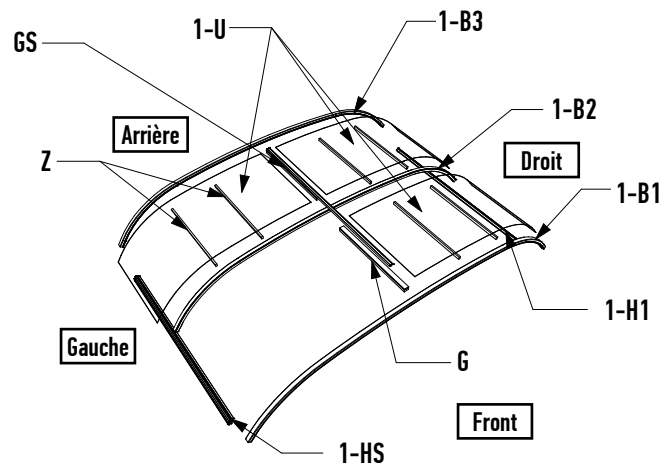

avec une porte coulissante sur le côté gauche

Item nr.	Item name	A3/4		A4/5		Notes
		A3	A4	A5		
1-B1	arceau no. 1	1		1		
1-B2	arceau no. 2	1		1		
1-B3	arceau no. 3	1		1		
1-H	traverse basse	1		1		
1-HS	traverse basse avec rail porte latérale	1		1		
1-U	plaque PC plein	3		3		
Z	barre de support	6		9		
G	profilé poutre	1		1		
GS	profilé poutre avec rail porte latérale	1		1		
1	vis torx à tête bombée	12		12		4,8 x 50
4	serrure	1		1		
9	cache arrière sans verrouillage	2		2		1 droit+ 1 gauche
10	verrouillage diss.	1		2		1 droit+ 1 gauche
18	cache arrière (sans serrure)(G-D)	1		2		1 droit+ 1 gauche
22	joint à poser côté extérieur*					

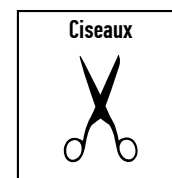
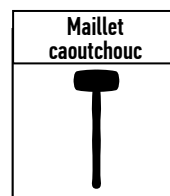
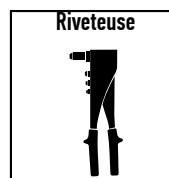
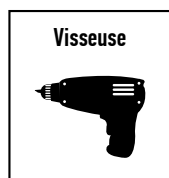
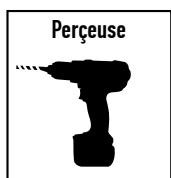

*avec PC plein



3 ASSEMBLAGE DU 1ER ÉLÉMENT

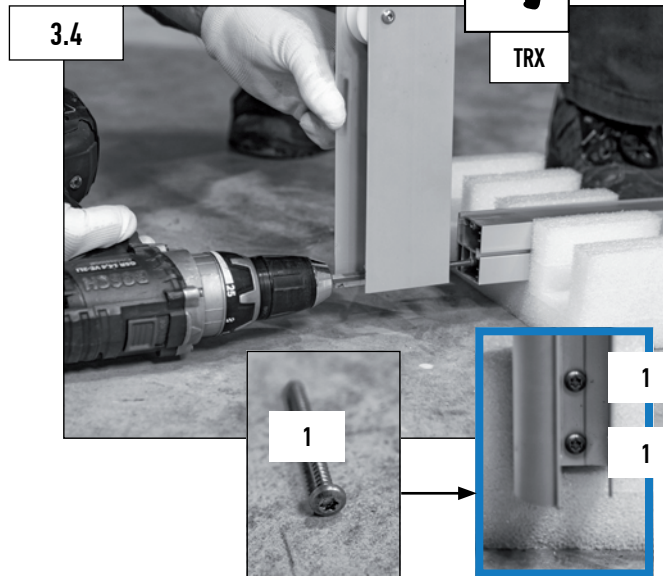
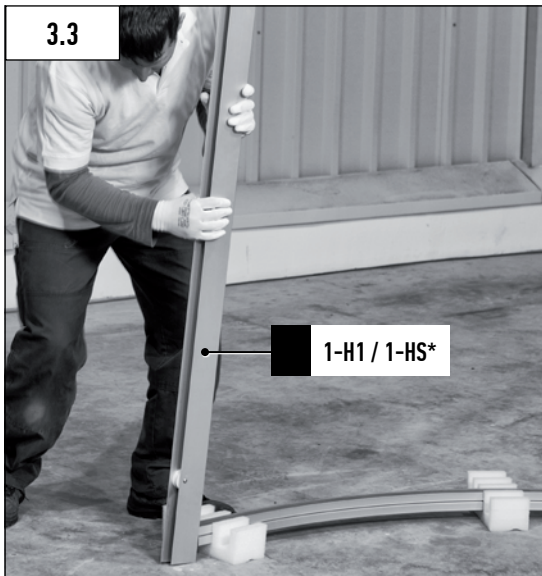
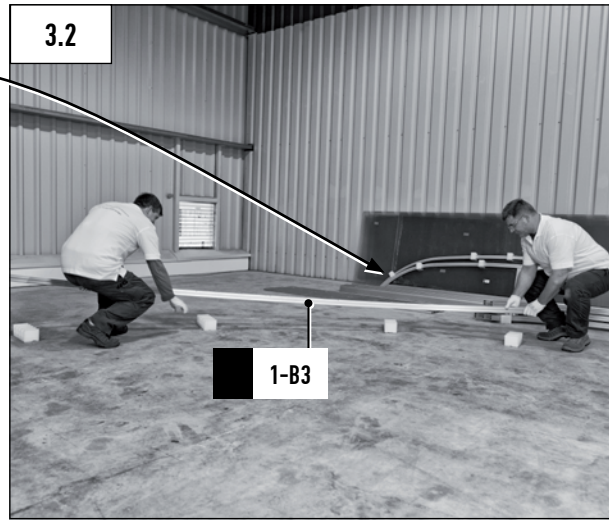
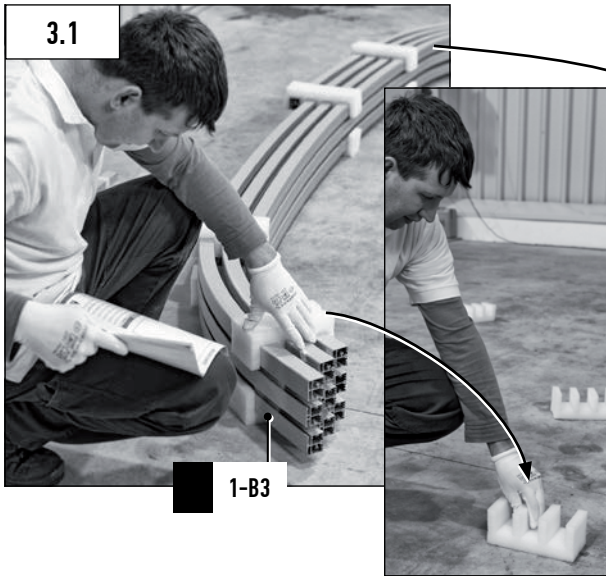

* 1-HS =
en cas de
porte latérale
coulissante

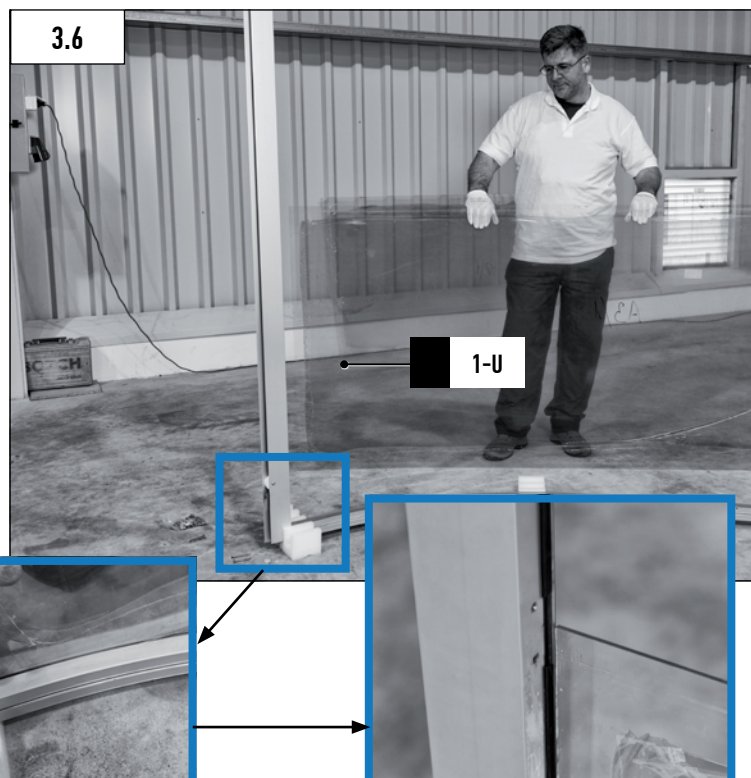

3 ASSEMBLAGE DU 1ER ÉLÉMENT

*M5

** A3, A3/4, A4S, A4L, A4, A4/5, A5

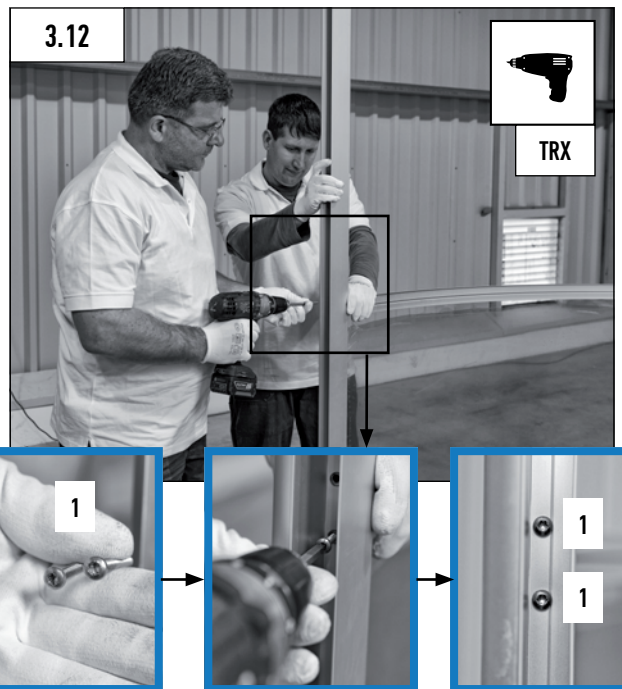
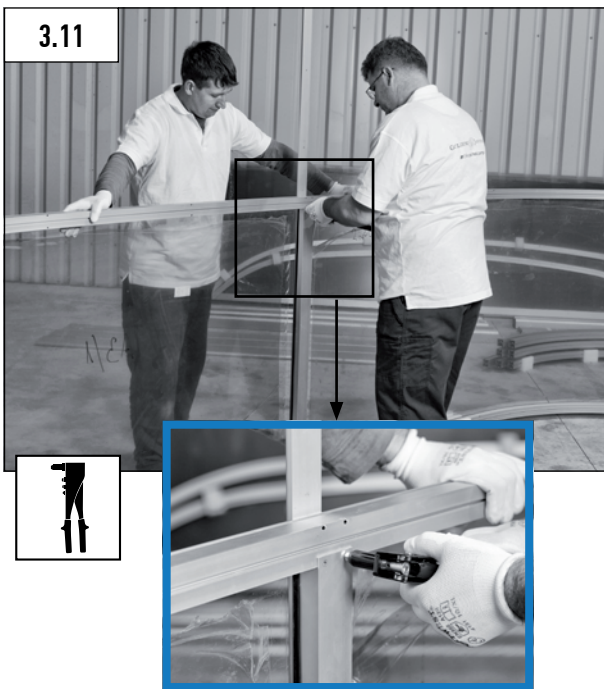
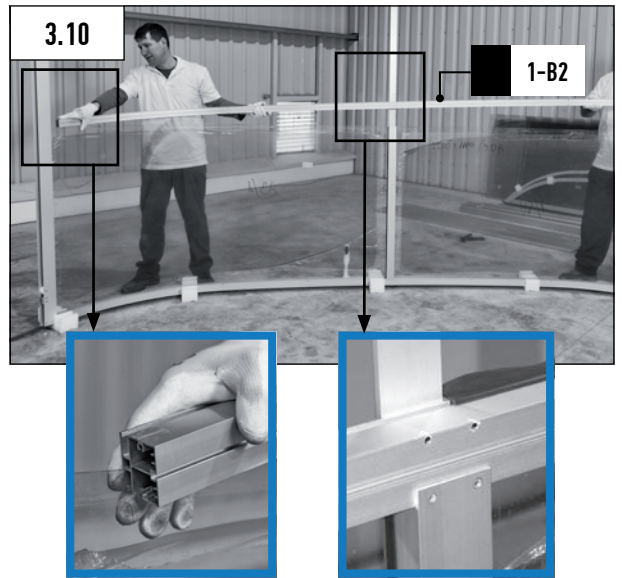
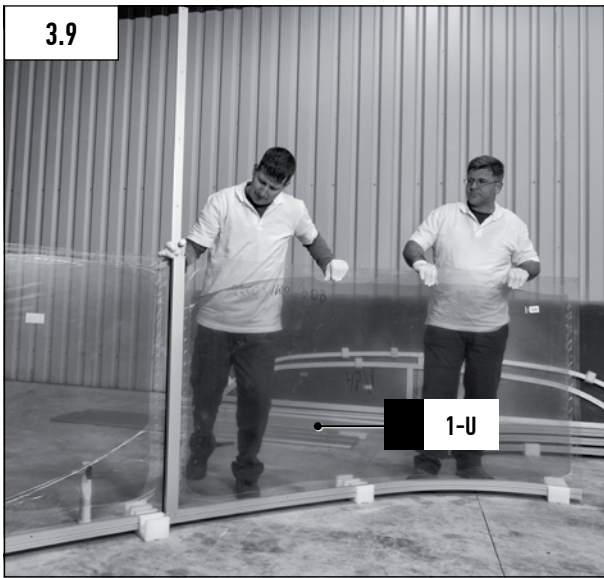
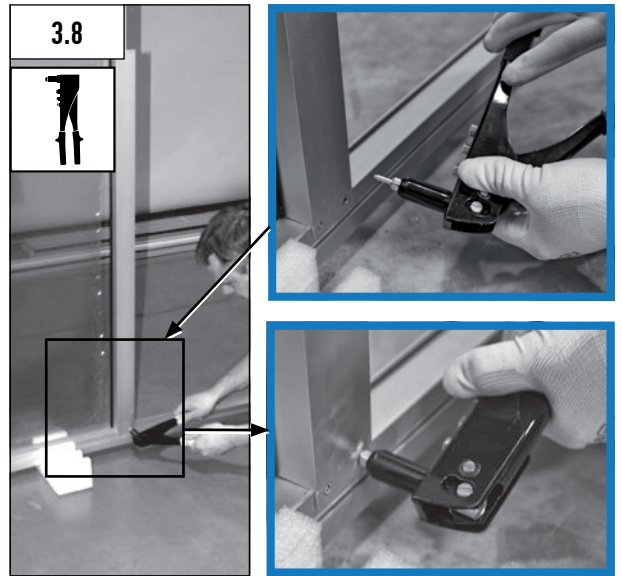
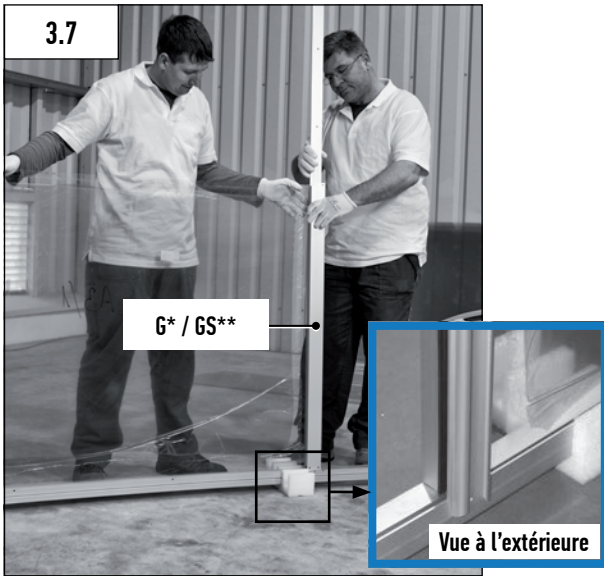

3 ASSEMBLAGE DU 1ER ÉLÉMENT

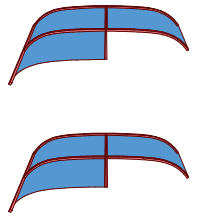
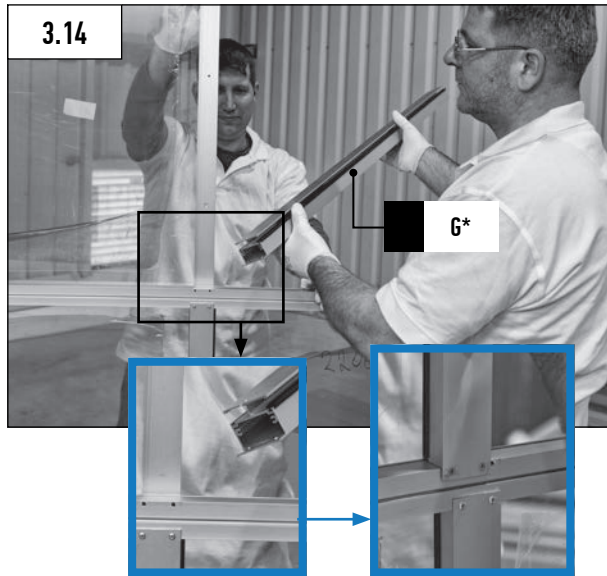
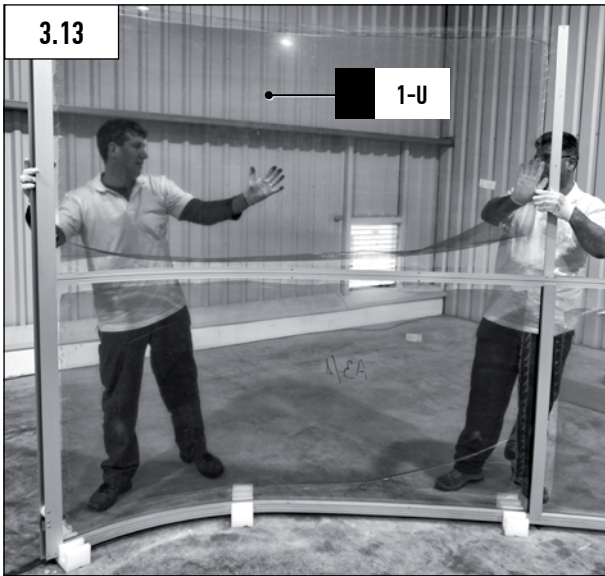

*A3, A3/4, A4S, A4L, A4, A4/5, A5, M5

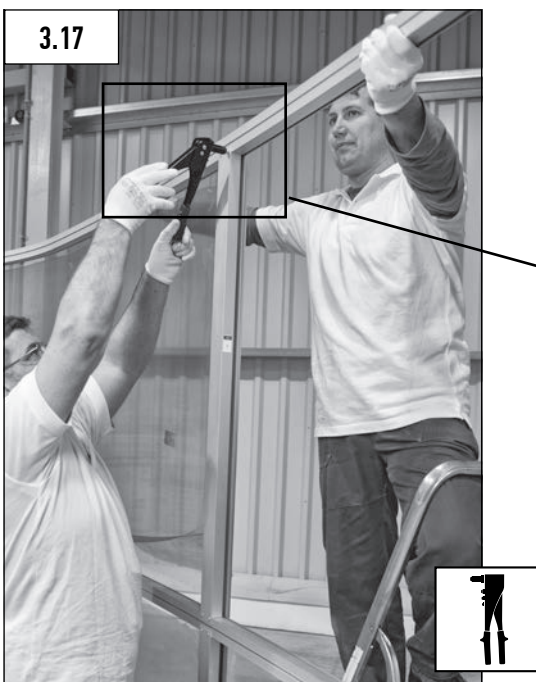
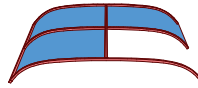
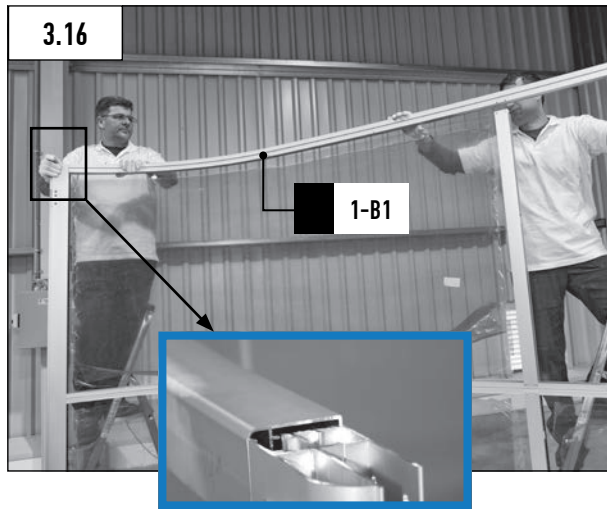

3 ASSEMBLAGE DU 1ER ÉLÉMENT

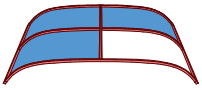
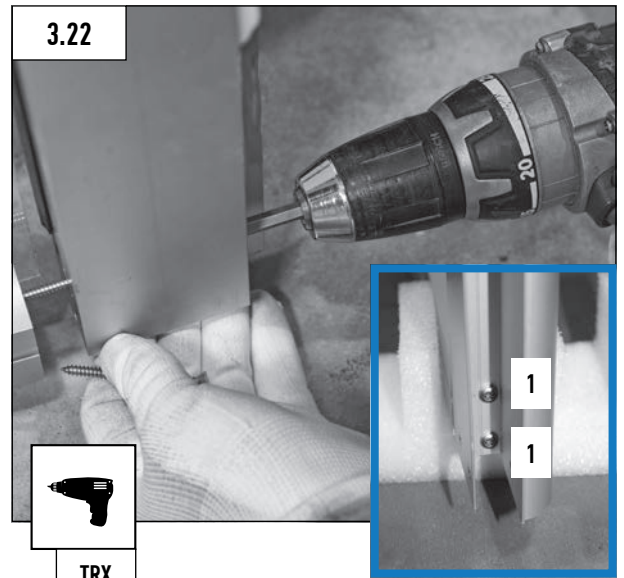
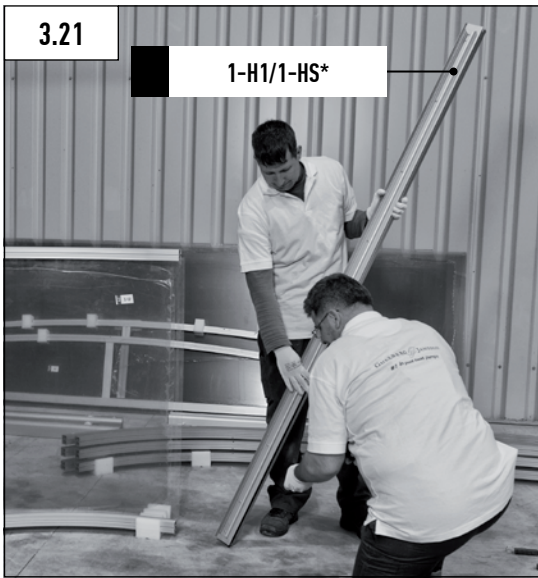
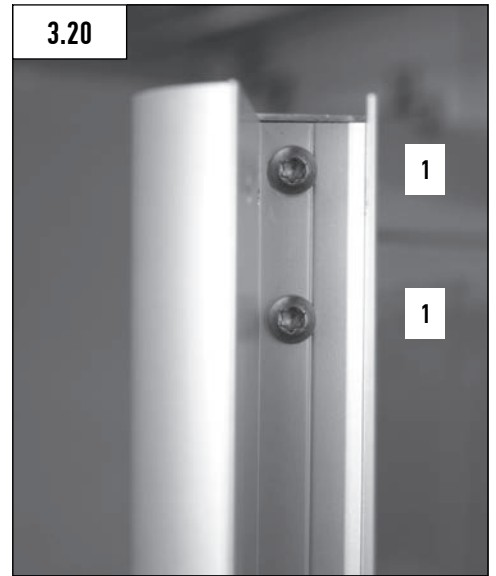
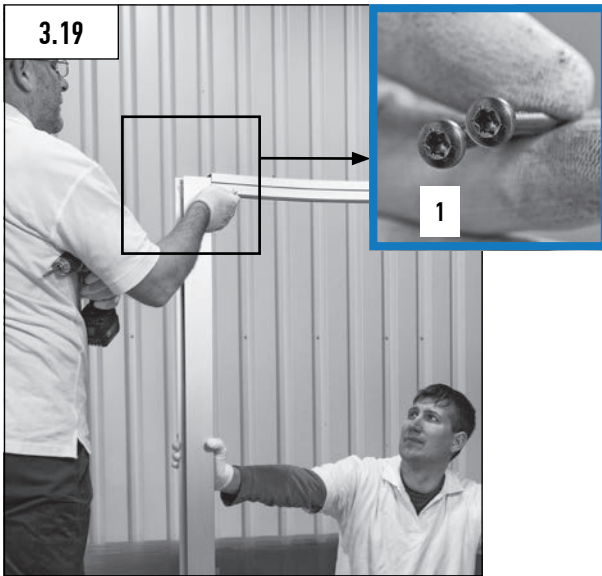

* A3, A3/4, A4S, A4L, A4, A4/5, A5 en cas de porte latérale coulissante

**M3, M4, M4/5 M5 coulissante

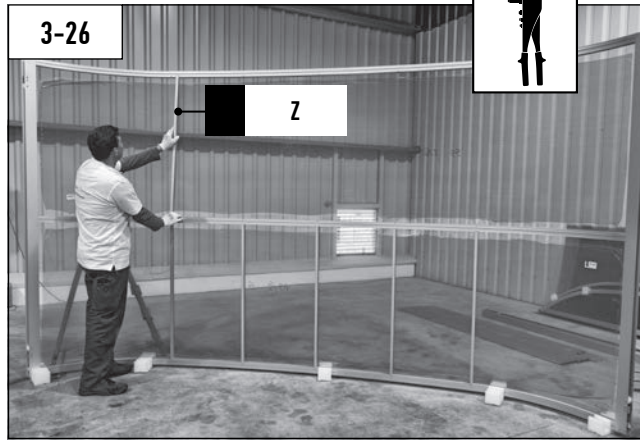

Plus d'informations sur le montage du profilé Z, page 34 images 4.17 - 4.18.

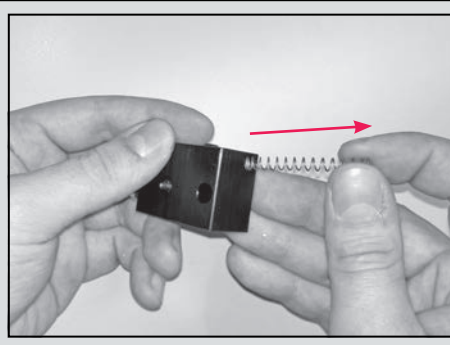
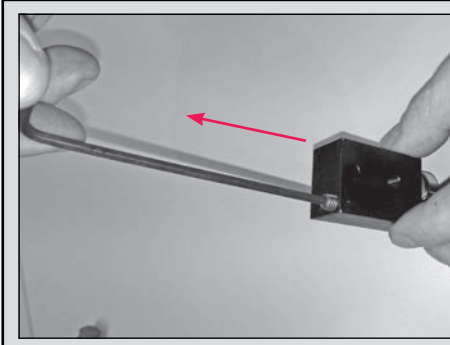

Option:
 Déboulonner le vis, enlever le ressort, l'élément sera verrouillé et fermé automatiquement.
 L'autre coté doit rester avec verrouillage manuel. (Ne pas enlever le ressort).

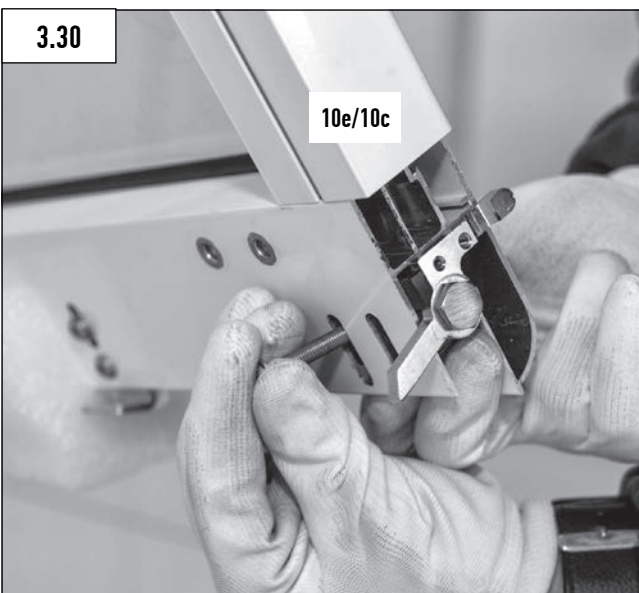
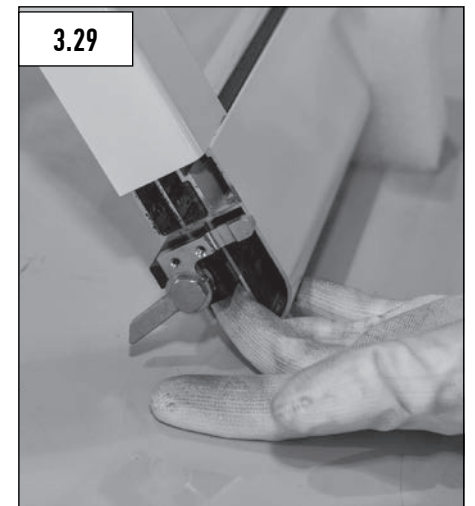
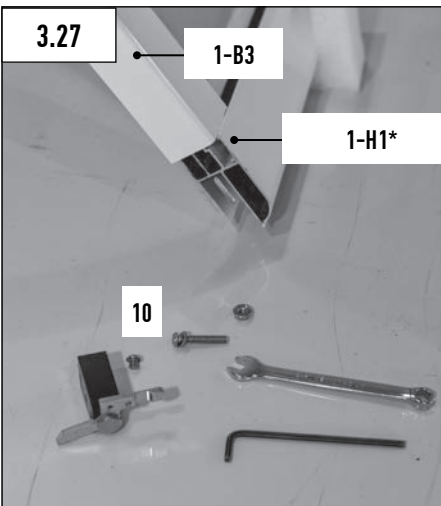

3 ASSEMBLAGE DU 1ER ÉLÉMENT

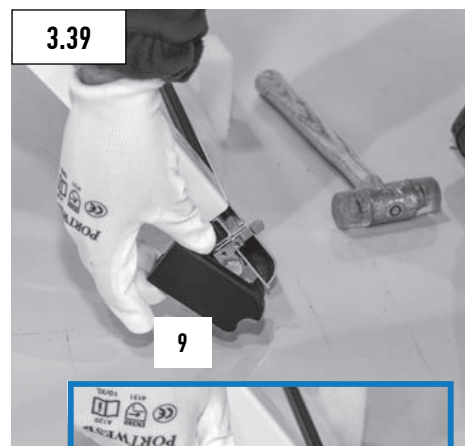
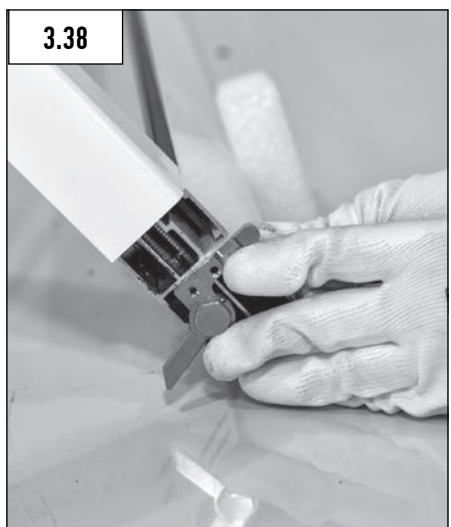
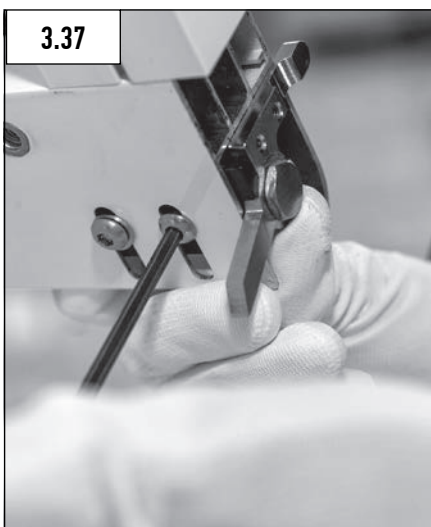
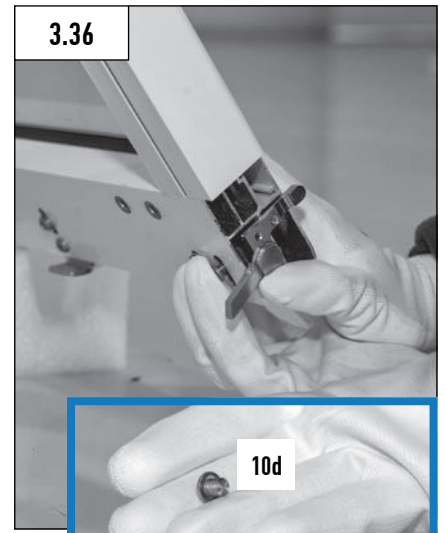
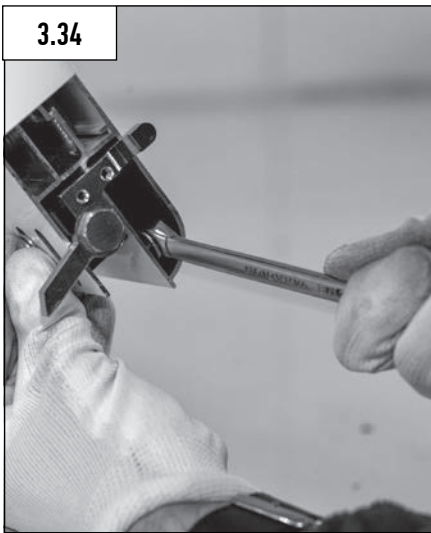
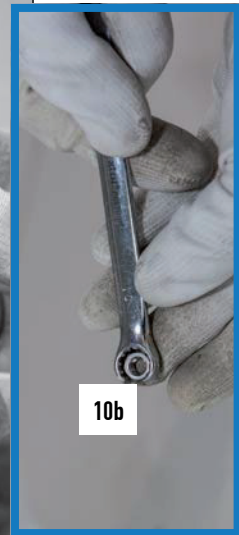
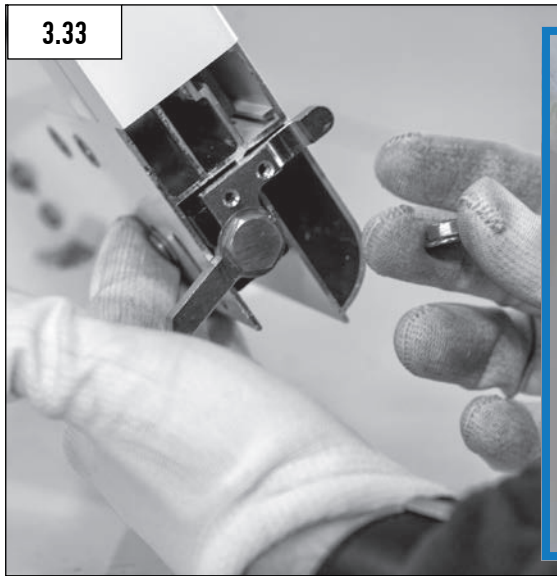
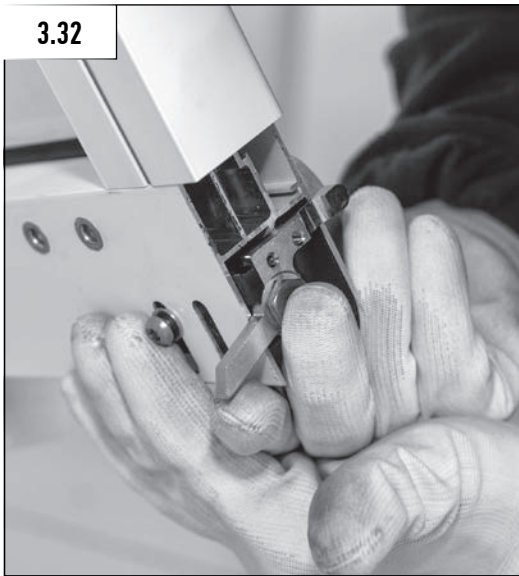

3 ASSEMBLAGE DU 1ER ÉLÉMENT

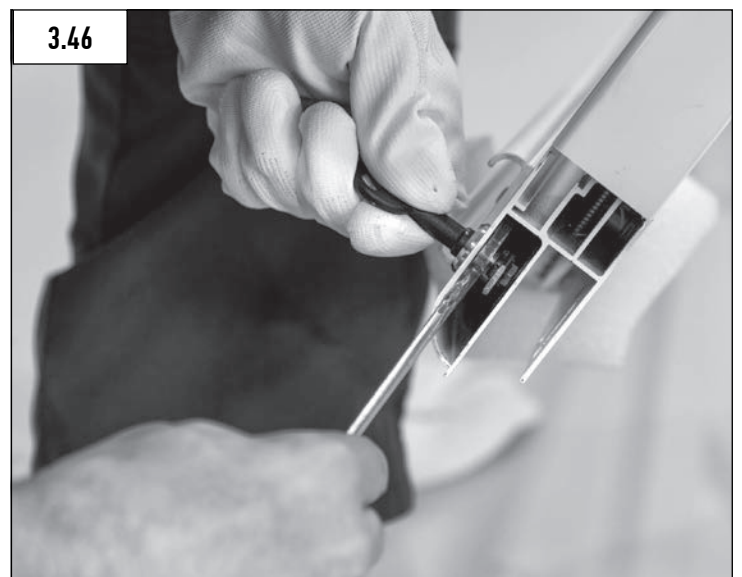
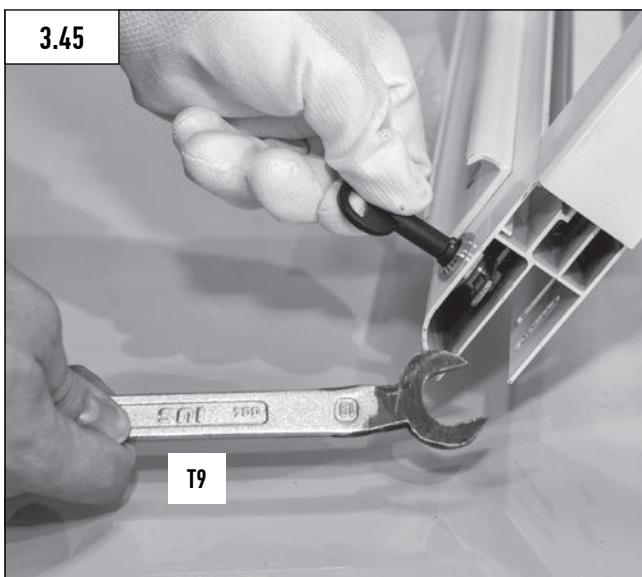
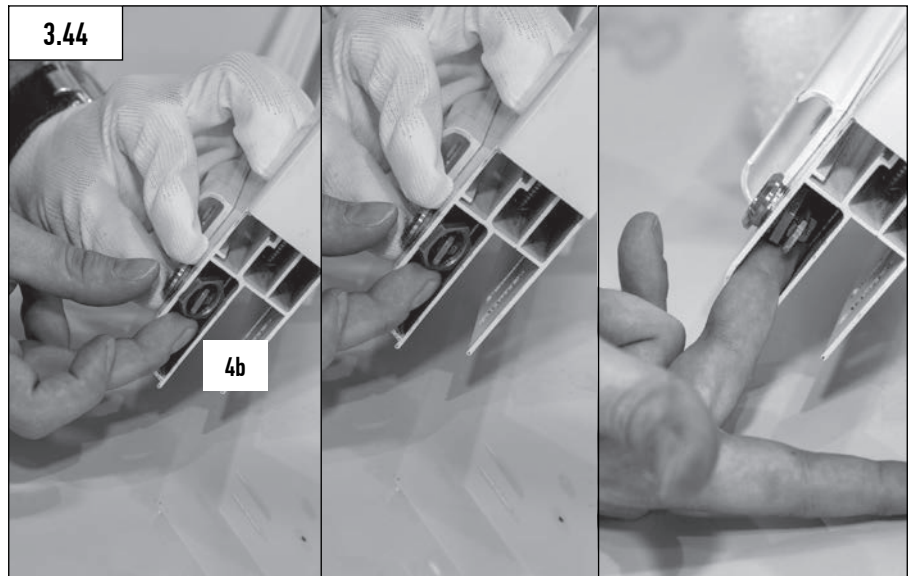
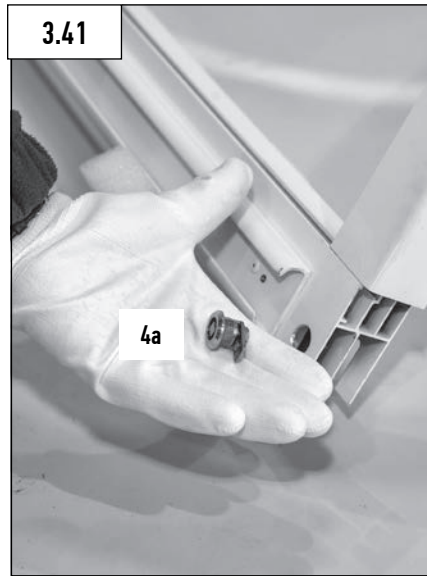
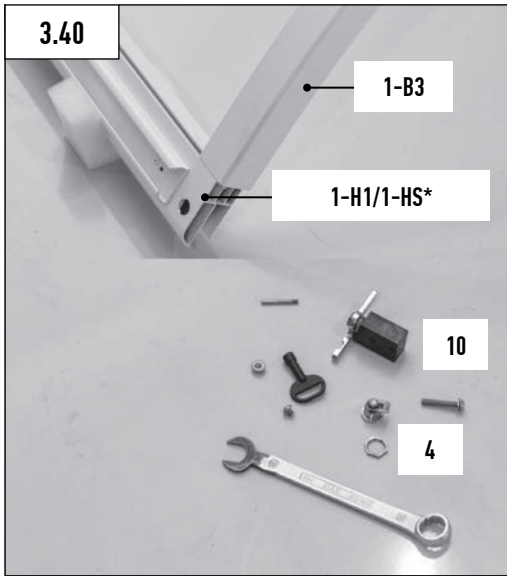

* A3, A3/4, A4,
A4/5, A5 en cas
de porte latérale
coulissante

3 ASSEMBLAGE DU 1ER ÉLÉMENT

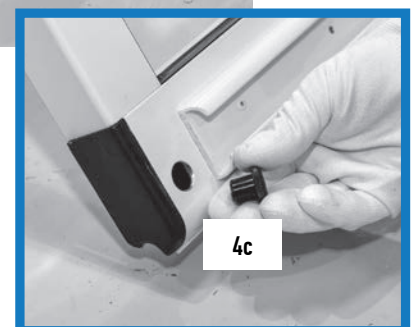
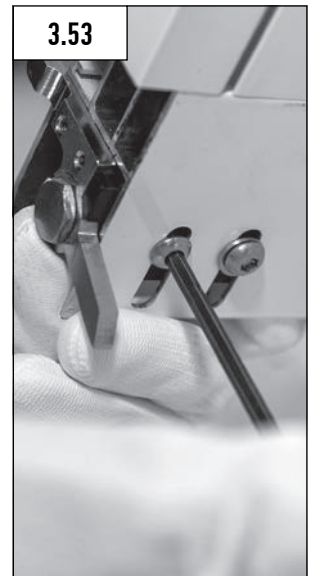
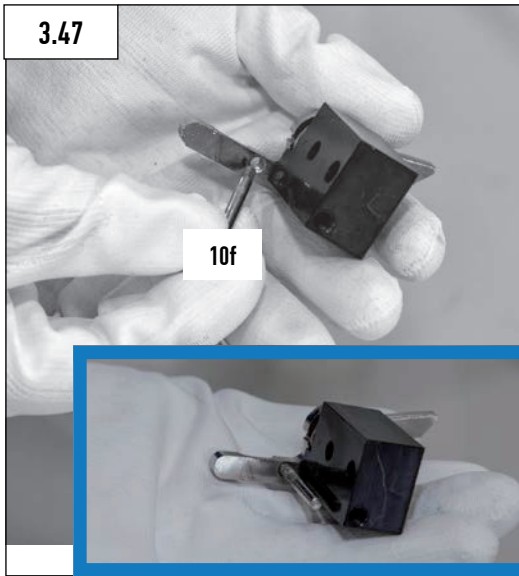

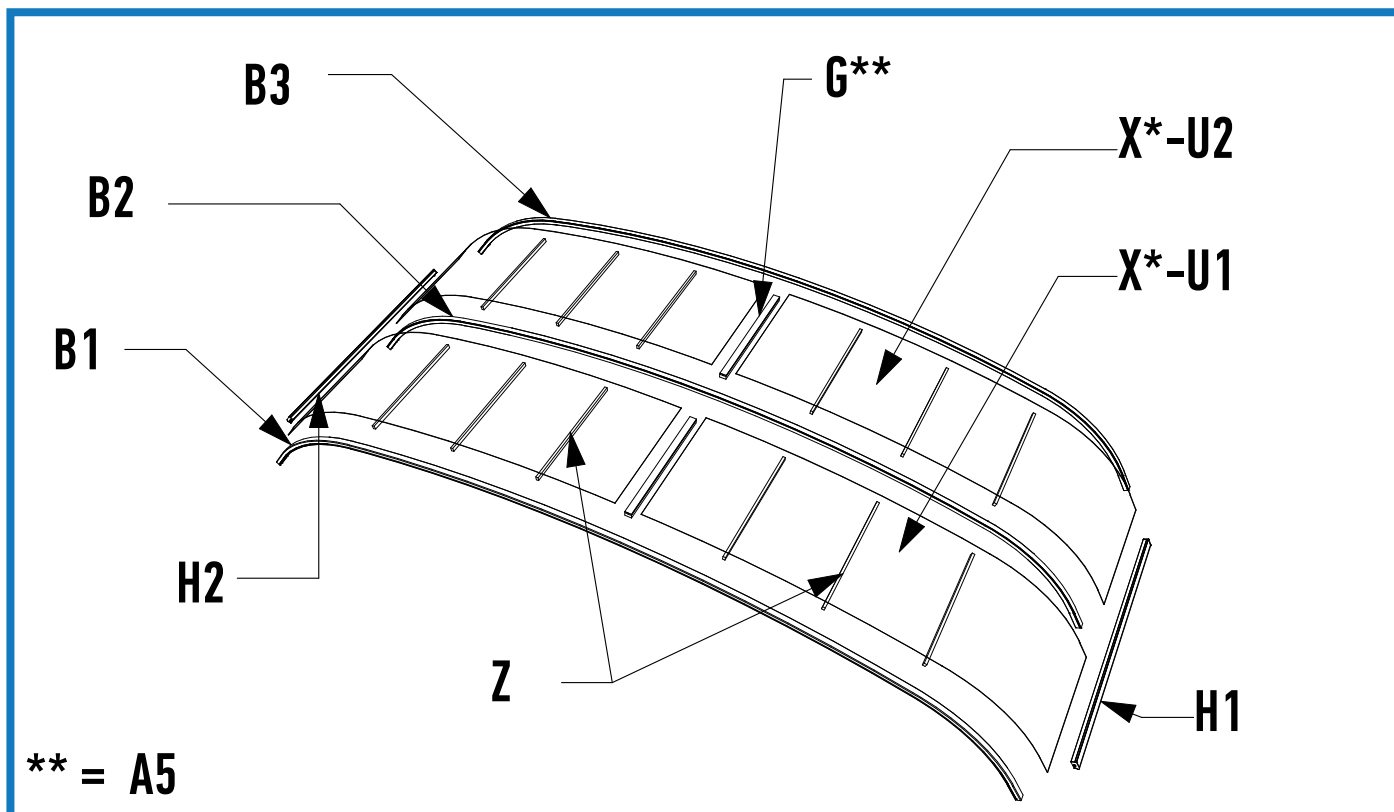

Item nr.	Item name	Pcs	Pcs	Pcs	Notes
x*-B1	arceau no. 1	1	1	1	
x*-B2	arceau no. 2	1	1	1	
x*-B3	arceau no. 3	1	1	1	
H1	traverse basse-droite	1	1	1	gauche
H2	traverse basse-gauche	1	1	1	droit
X*-U1	Plaque PC plein / Pc alvéo	1	1	2	
X*-U2	Plaque PC plein / Pc alvéo	1	1	2	
Z	barre de support	8	10	12	
G	profilé poutre	-	-	2	
1	Vis torx à tête bombée	12	12	12	4,8 x 50
12	verrouillage avec bec	1	1	1	1
18	plaques de deviation	1	1	1	1 droit+ 1 gauche
9	cache de arrière (verrouillage)	1	1	1	1 droit+ 1 gauche
11	cache de arrière (coté joint)	1	1	1	1 droit+ 1 gauche
22	joint extérieur****				

**** en cas de remplissage PC plein

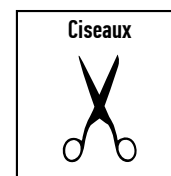
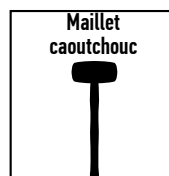
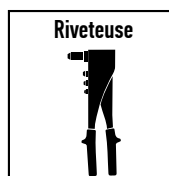
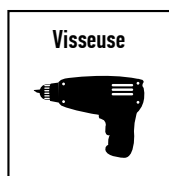
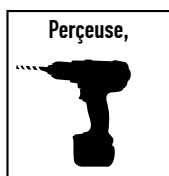

4 ASSEMBLAGE DE L'ÉLÉMENT INTERMÉDIAIRE

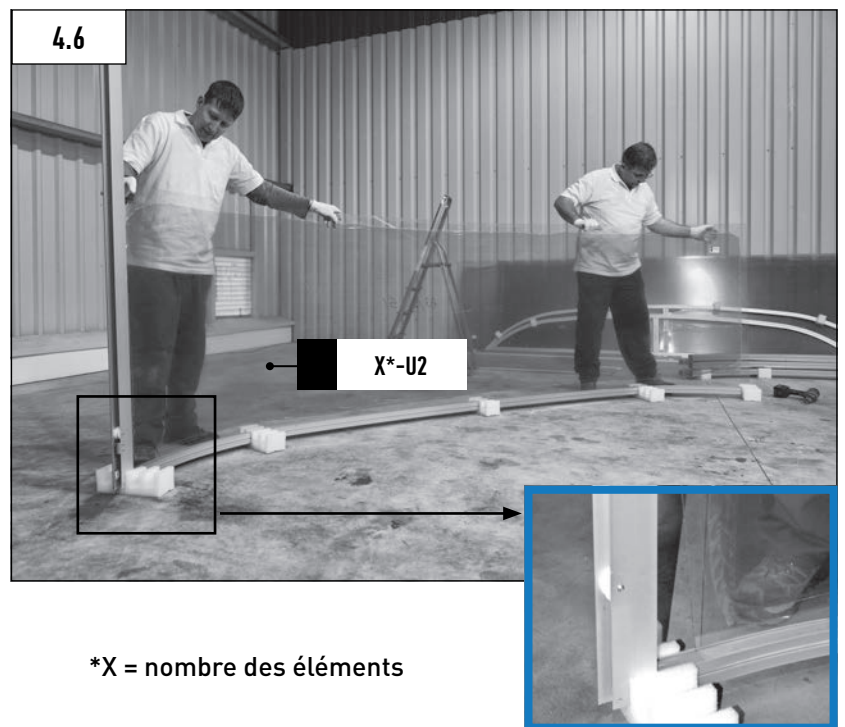
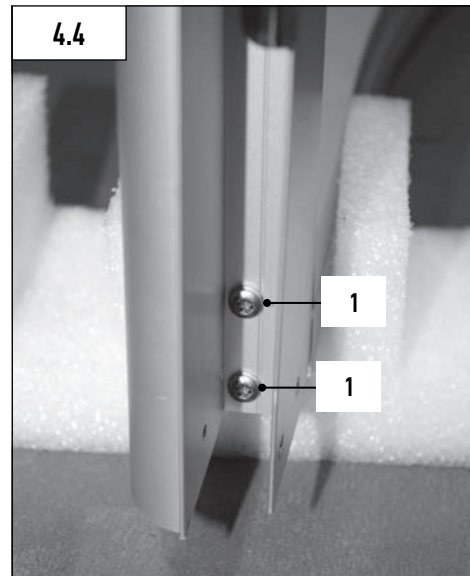
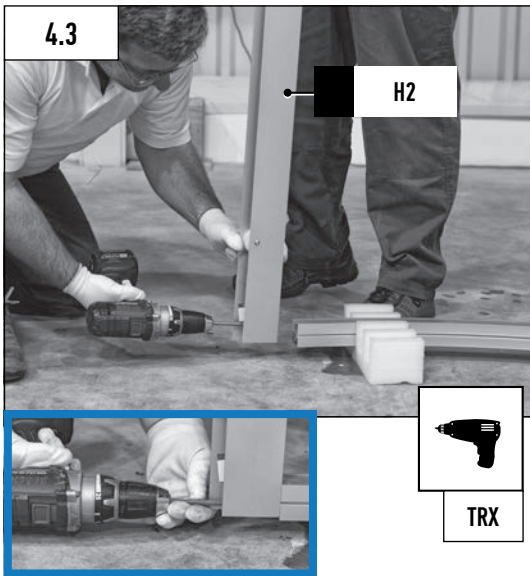
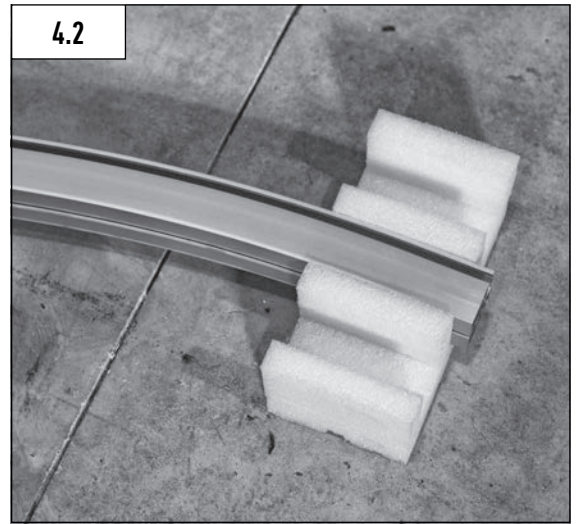
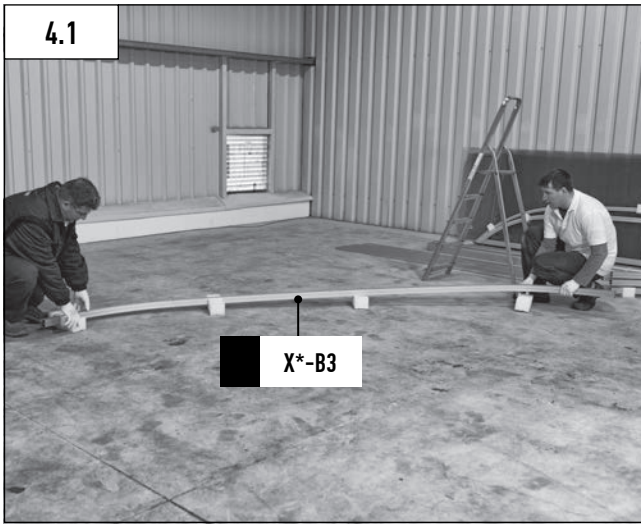

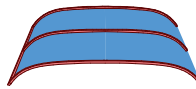
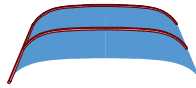
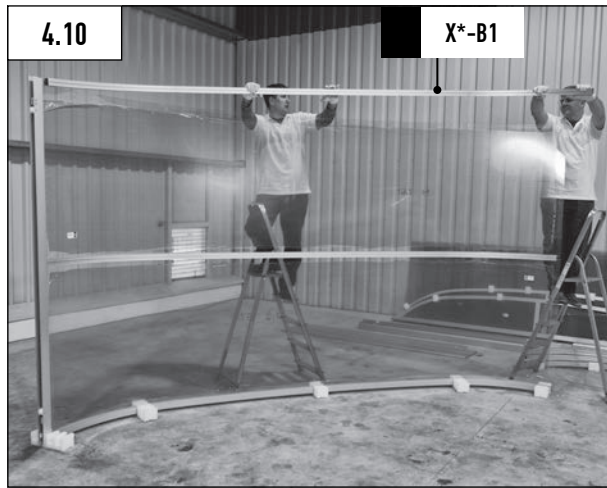
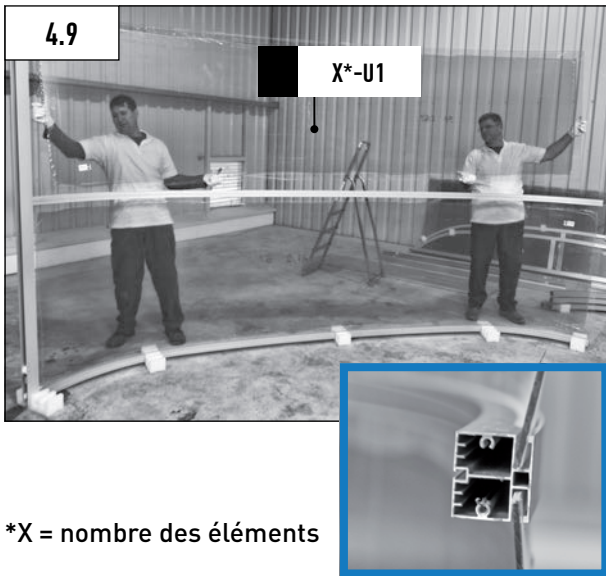
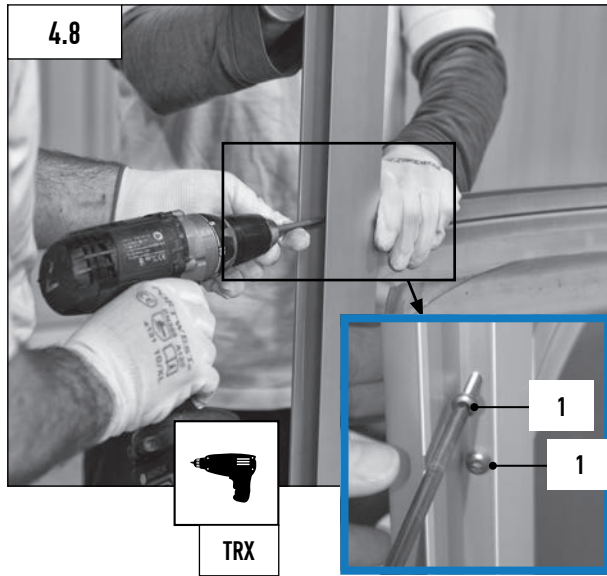
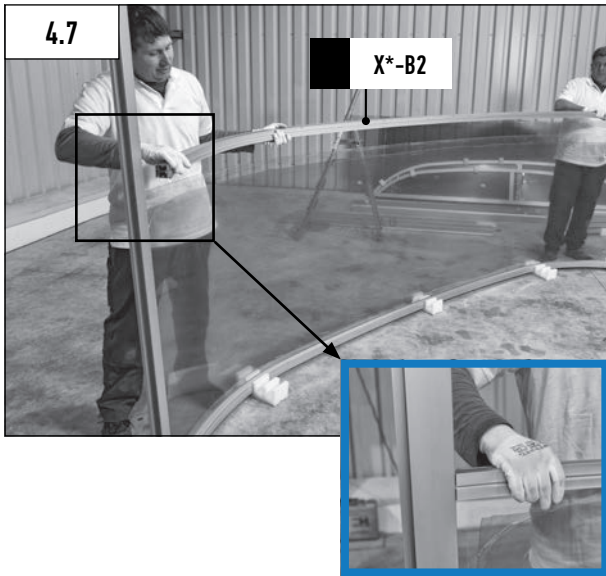

*X = nombre des éléments

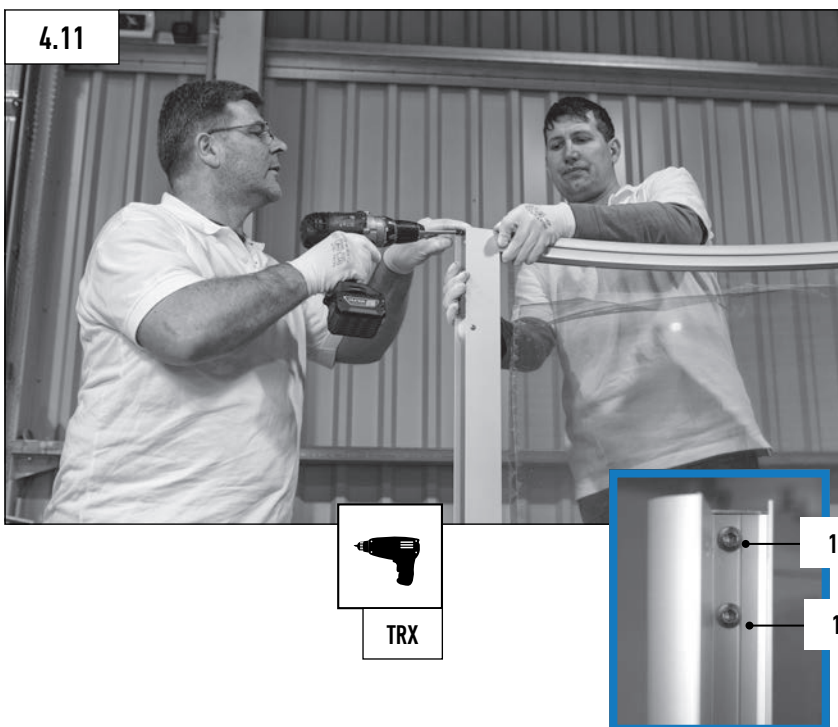

4 ASSEMBLAGE DE L'ÉLÉMENT INTERMÉDIAIRE

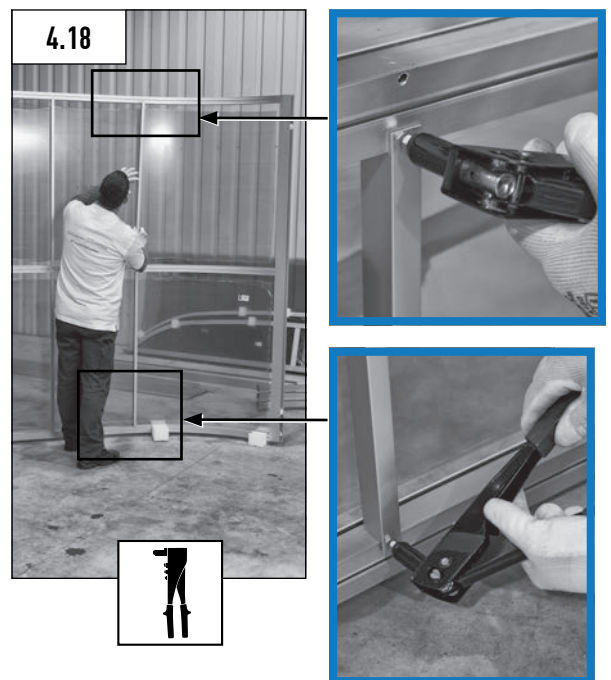
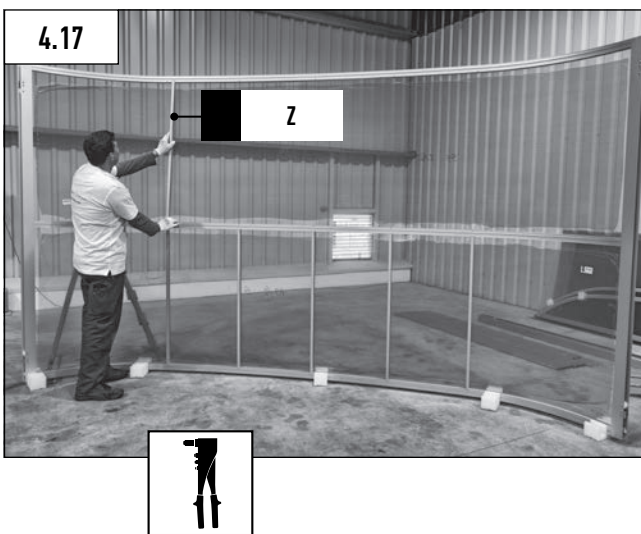
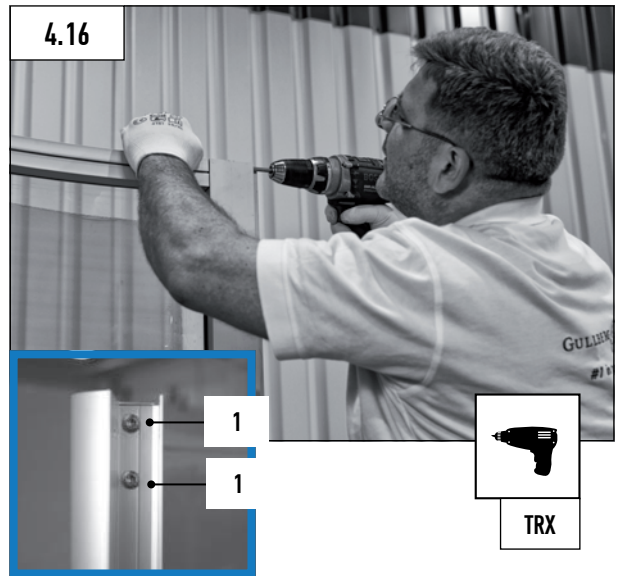
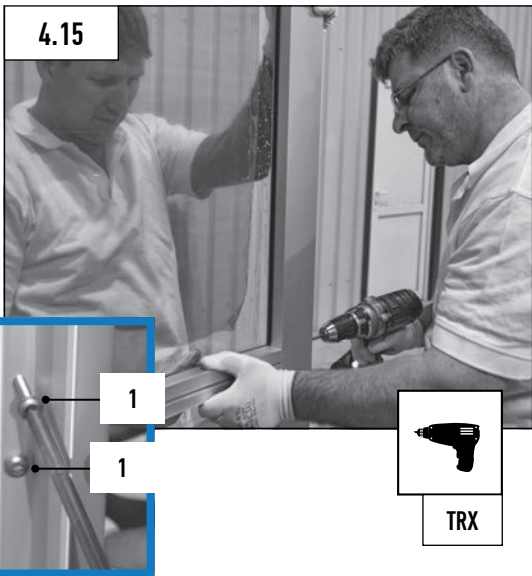
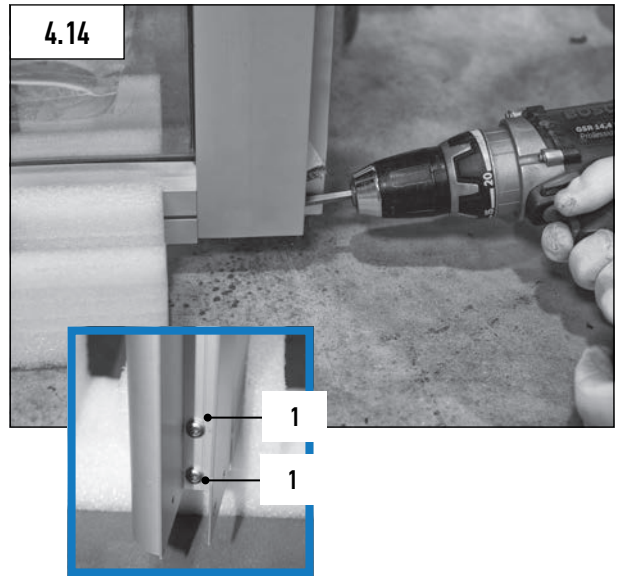
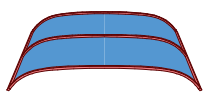

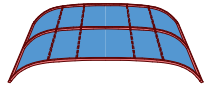

4 ASSEMBLAGE DE L'ÉLÉMENT INTERMÉDIAIRE

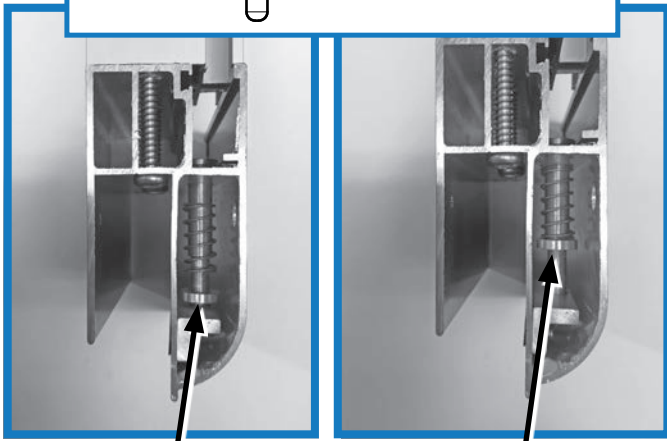
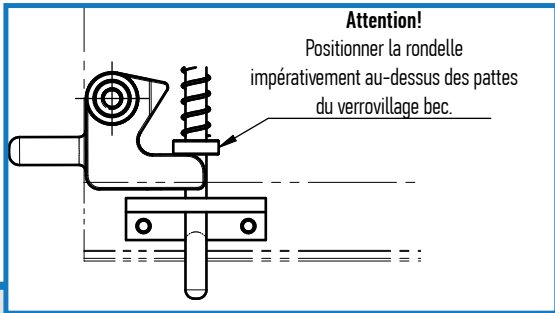
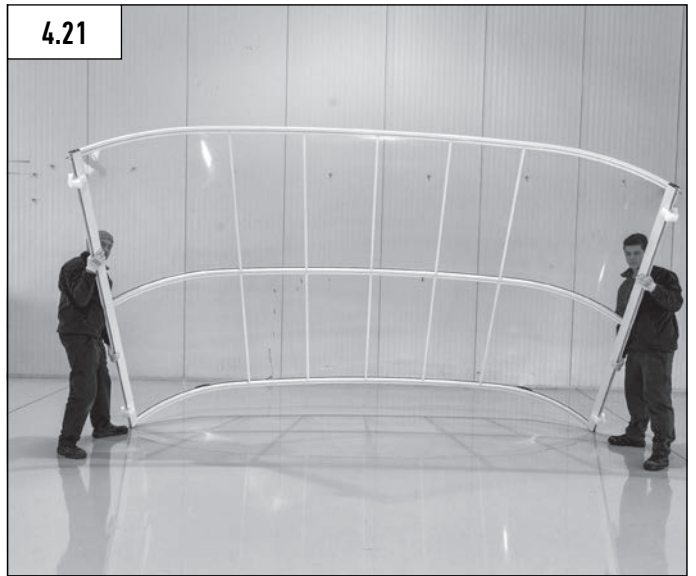
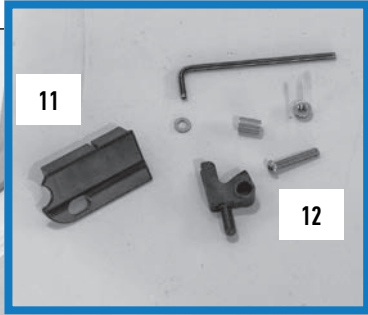
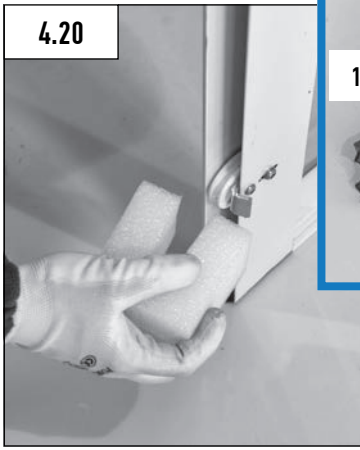

Fautif

Correct

Vérifier la position de la rondelle!

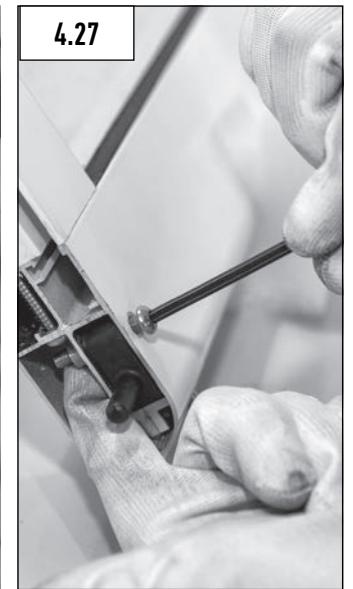
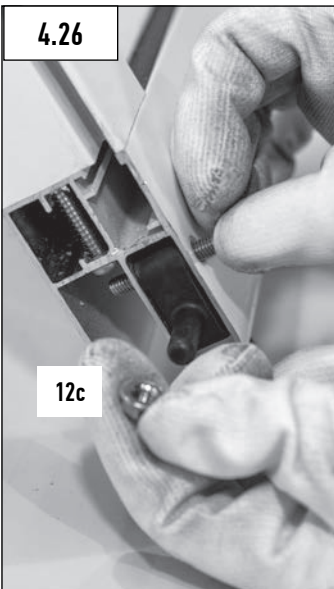
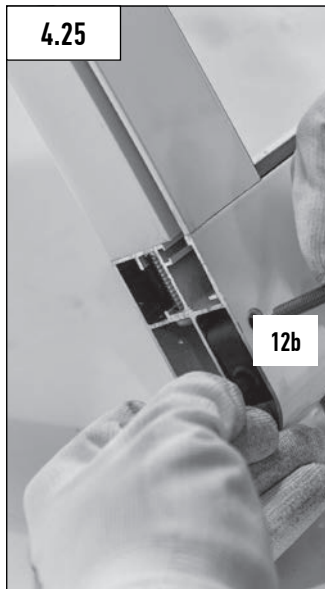
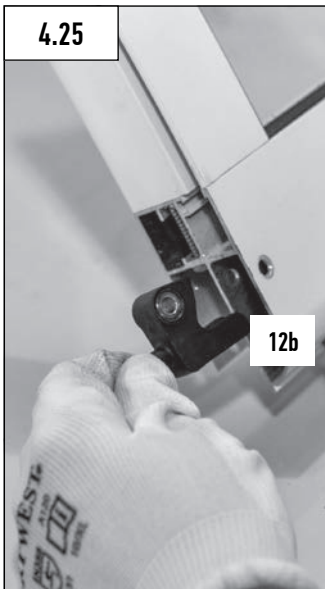

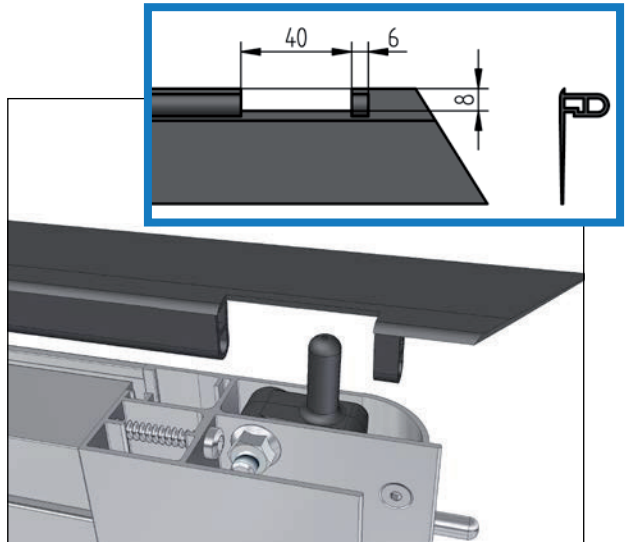
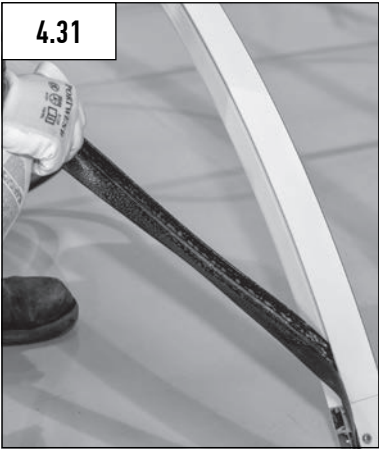
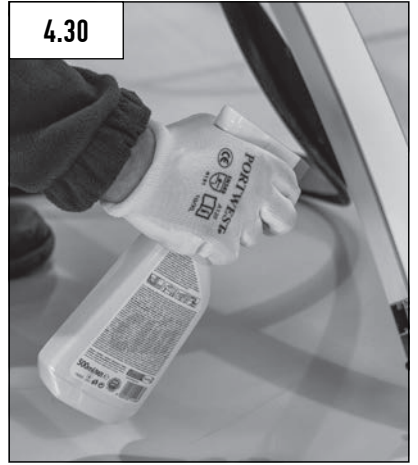
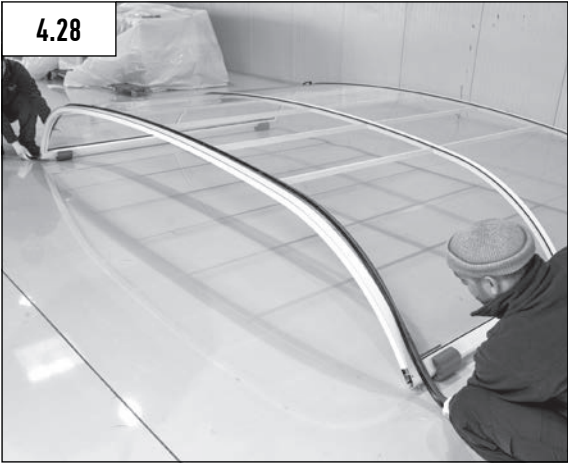

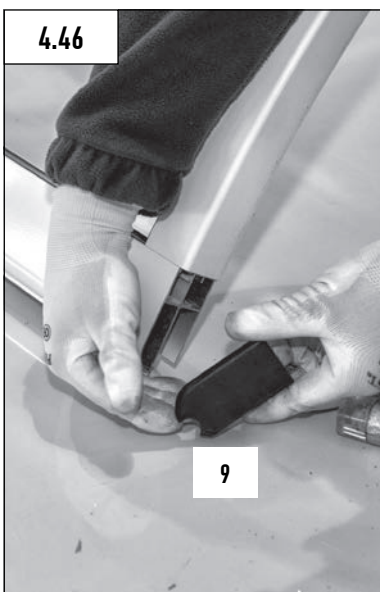
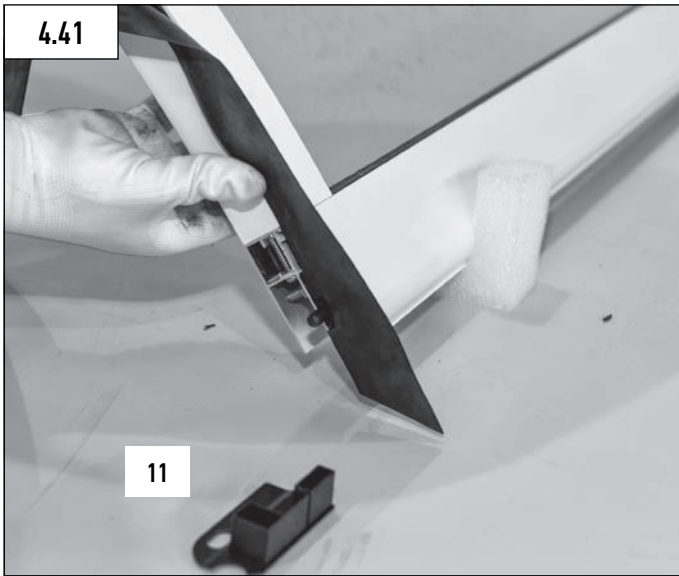

**Répéter les démarches
4.1-4.47
(voir page 30-36)**

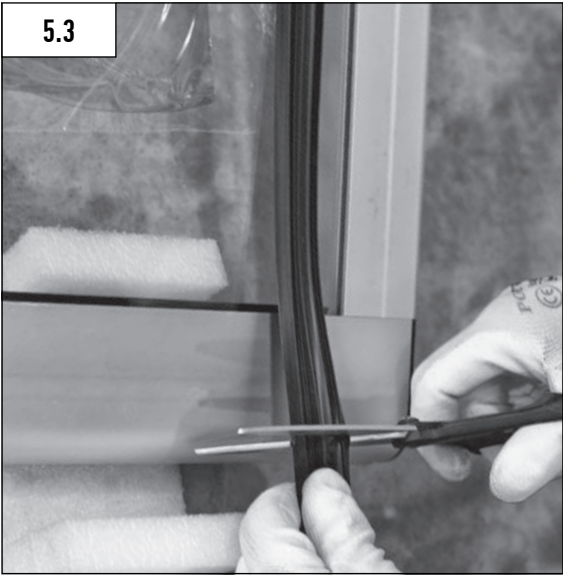
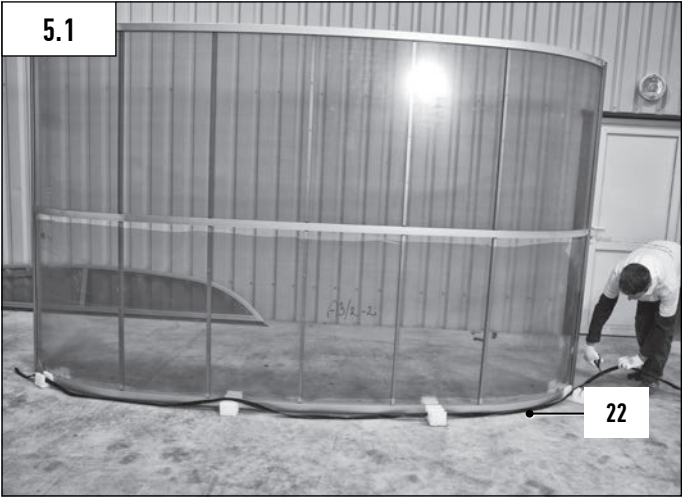



5.13



5.14



5.15



5.16

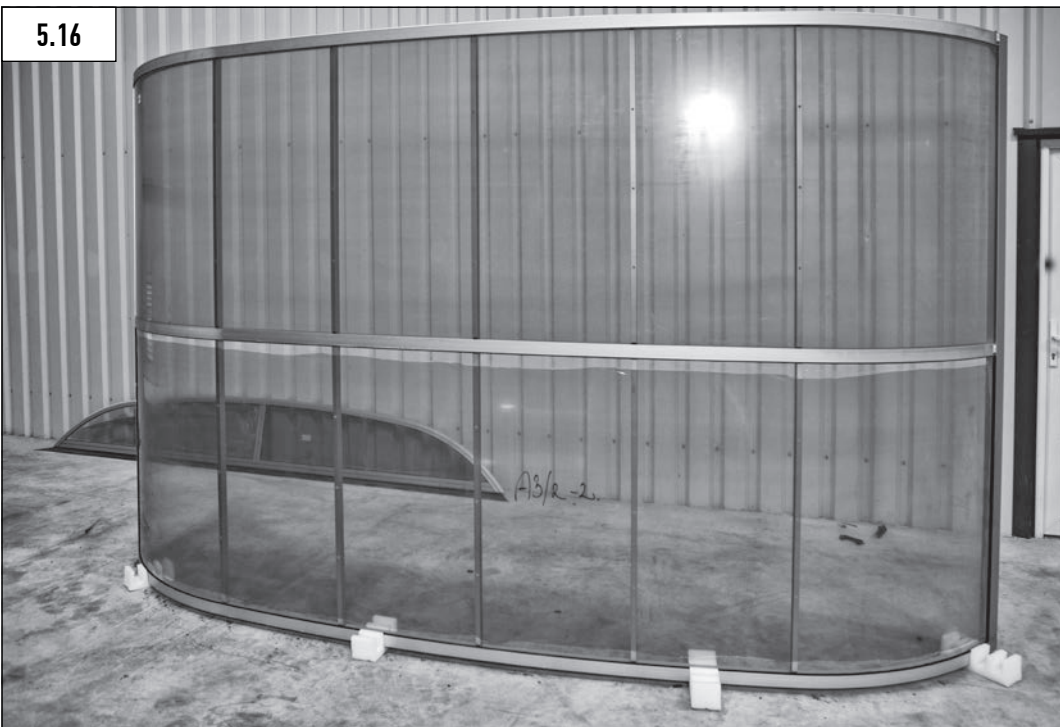

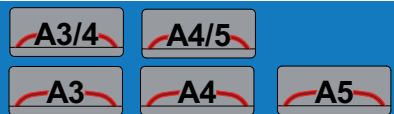
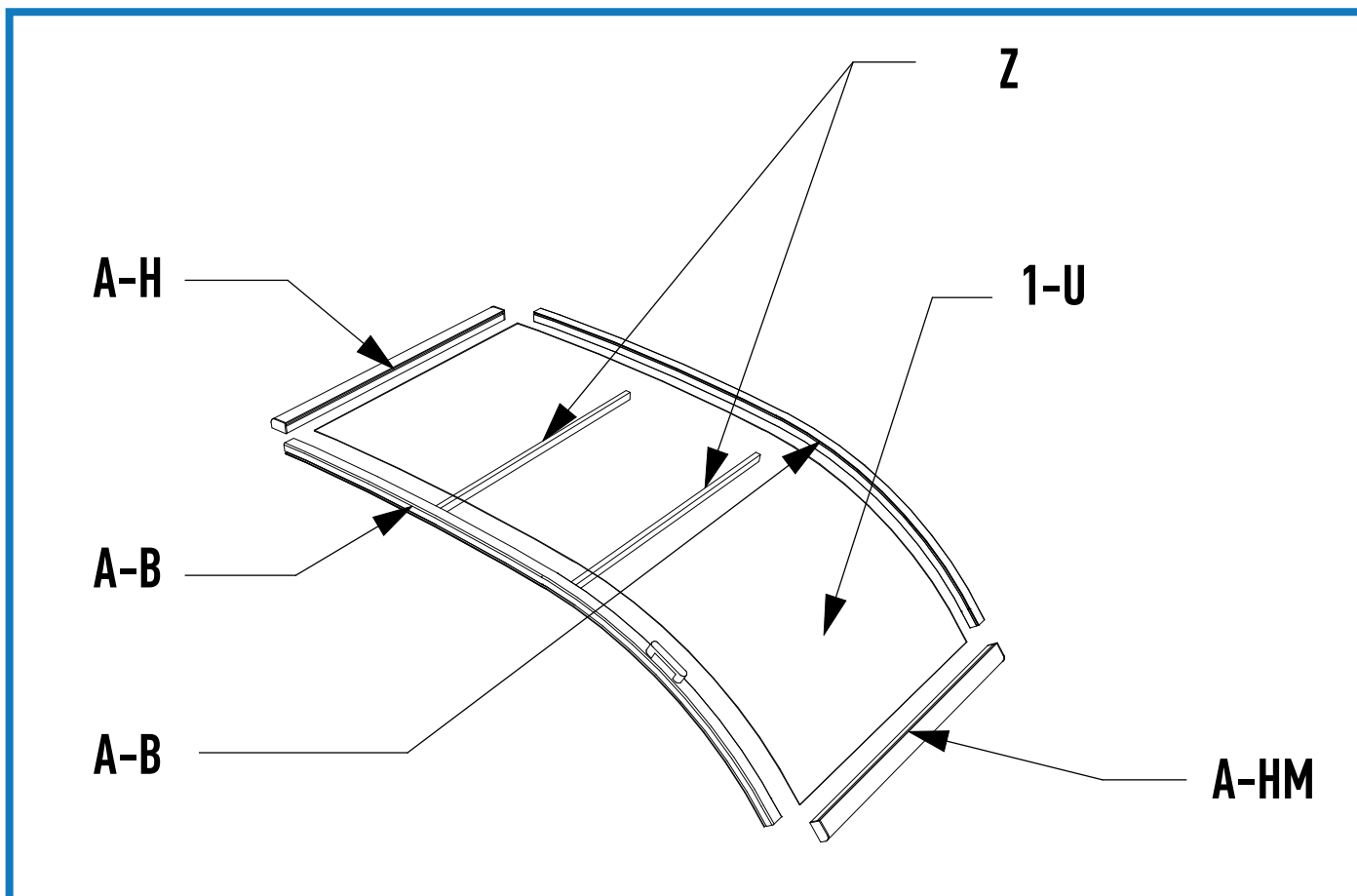

no. article	dénomination	pc	pc	note
A-B	arceau no. 1	1	1	
A-B	arceau no. 2	1	1	
A-H	traverse basse	1	1	
A-HM	traverse basse marquée	1	1	
1-U	plaque PC / PC alvéo	1	1	
Z	barre de support	2	3	
1	vis torx à tête bombée	8	8	
15a	Serrure porte latérale	1	1	
17	Bouchon porte latérale	8	8	
21	Joint inférieur porte latérale	1	-	
22	Joint extérieur et intérieur*			

*en cas de remplissage PC plein

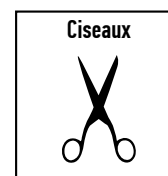
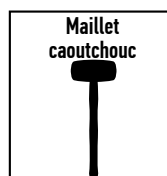
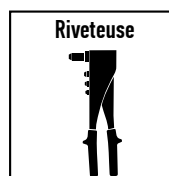
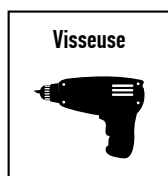
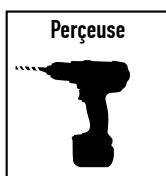

6 ASSEMBLAGE DE PORTE LATÉRALE COULISSANTE

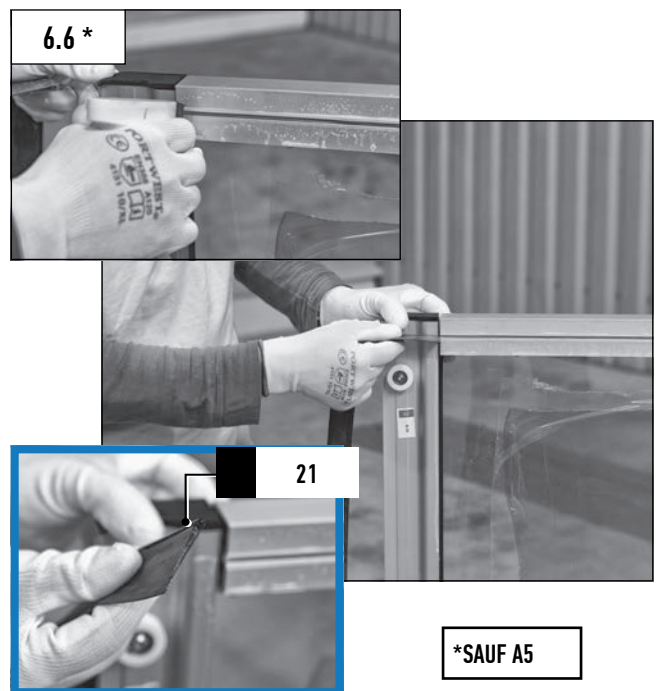
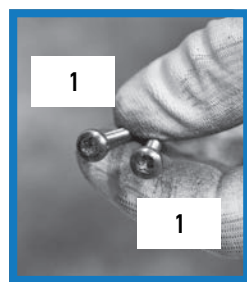
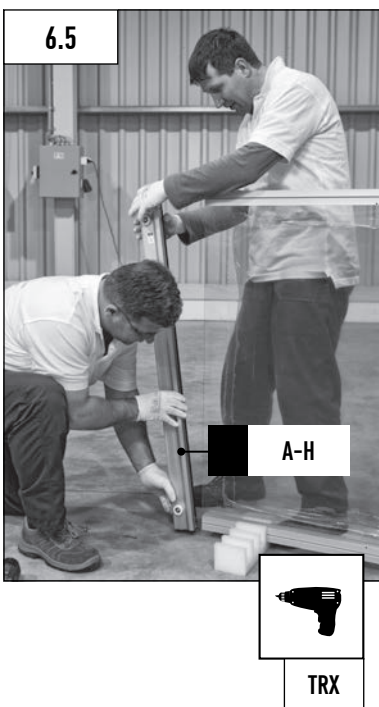
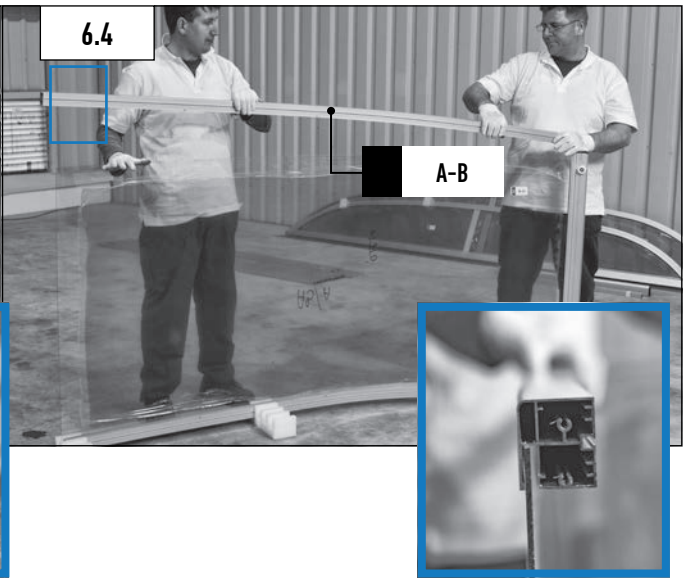
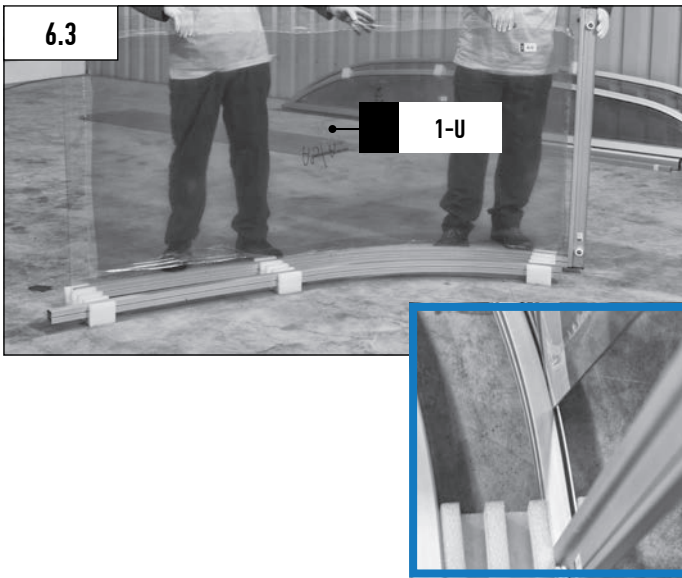
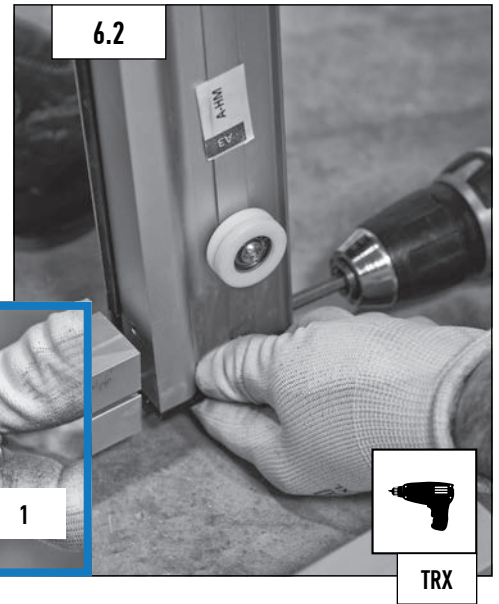
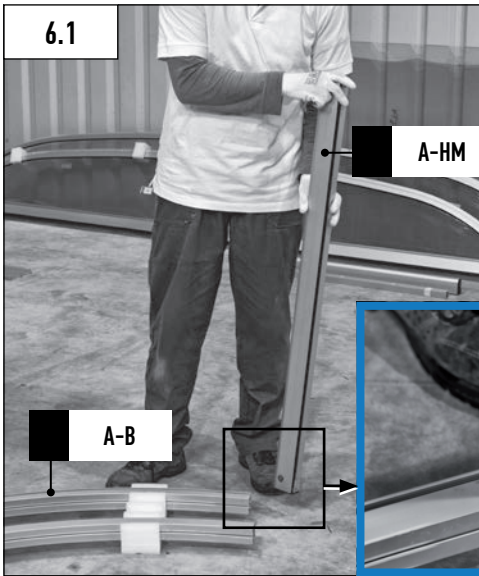



6.7*

*SAUF A5, M5

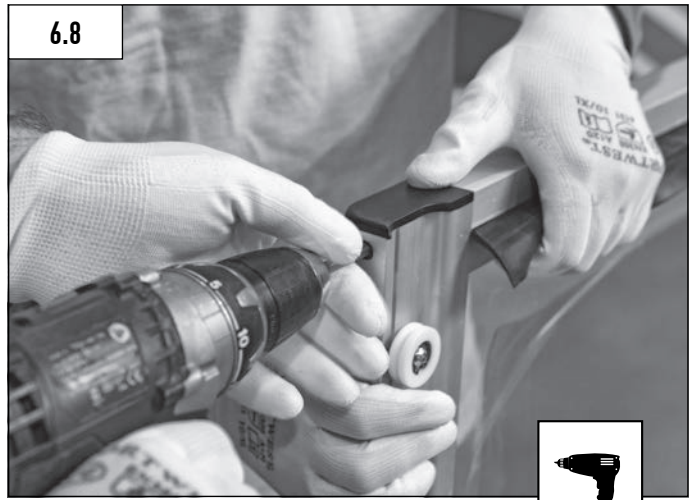
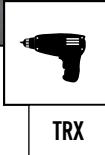

6.8

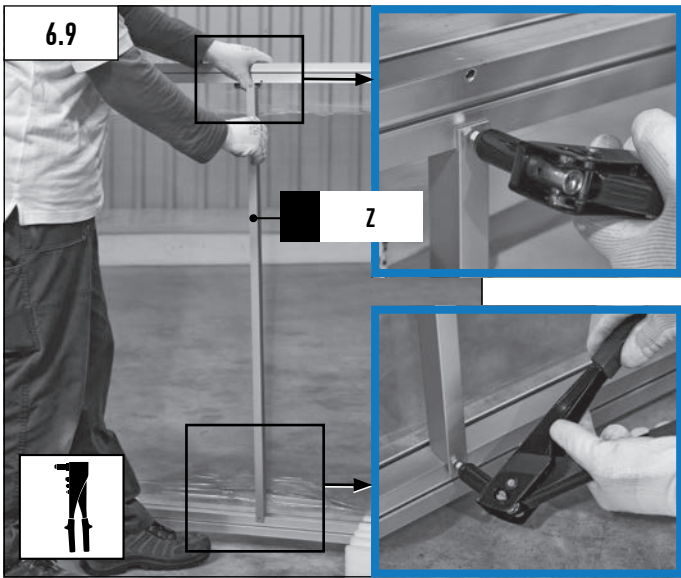
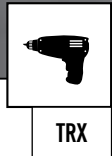

6.9

Z



6.10

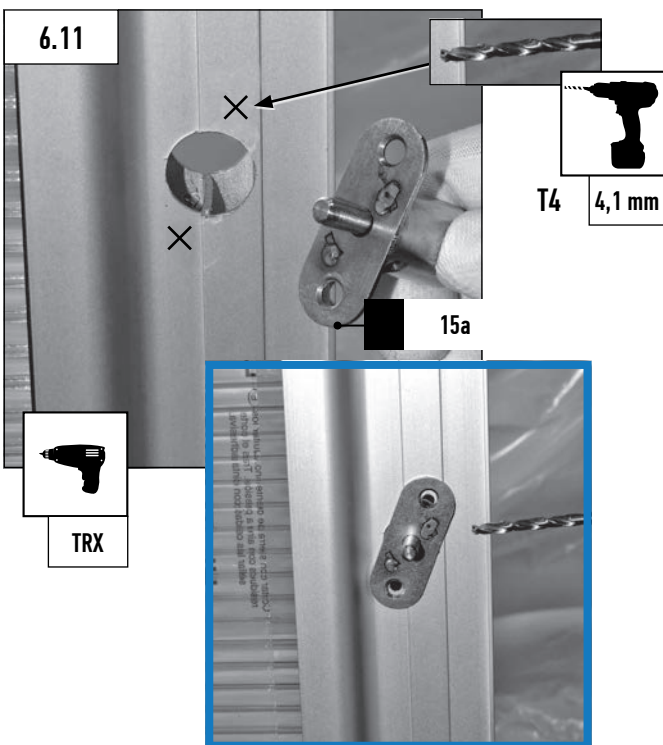

6.11

T4 4,1 mm

15a

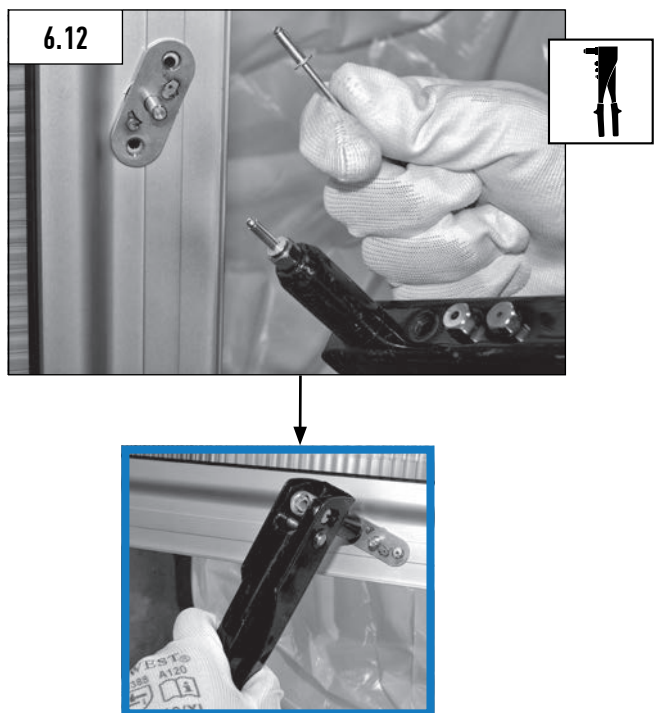

6.12



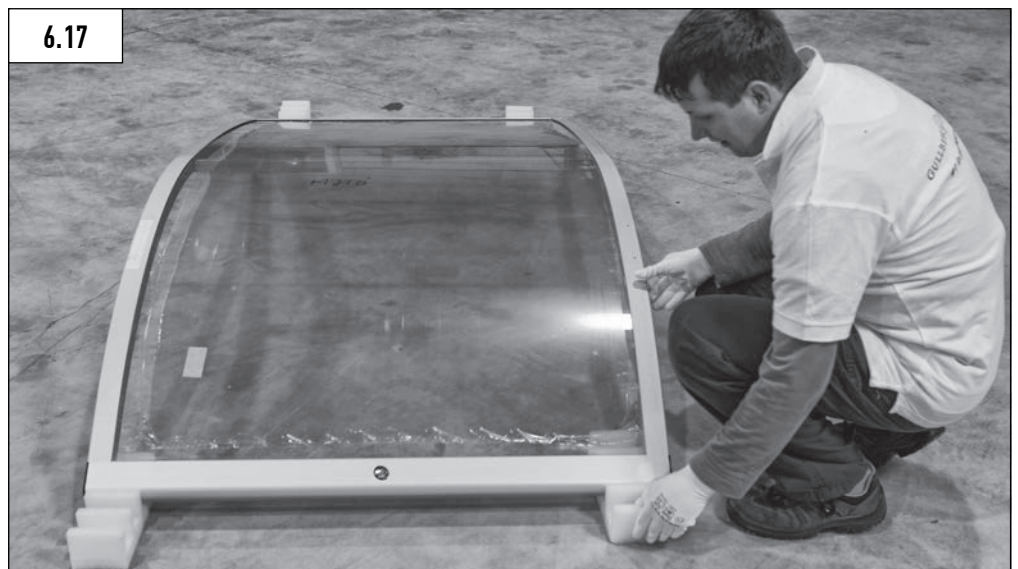
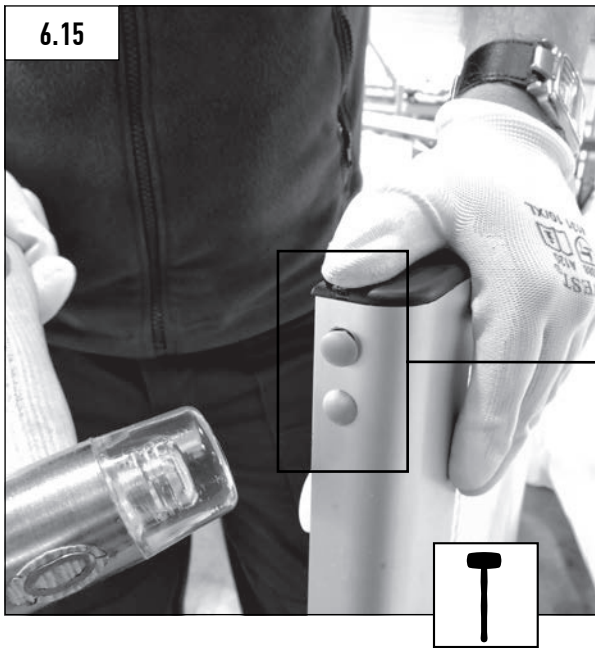
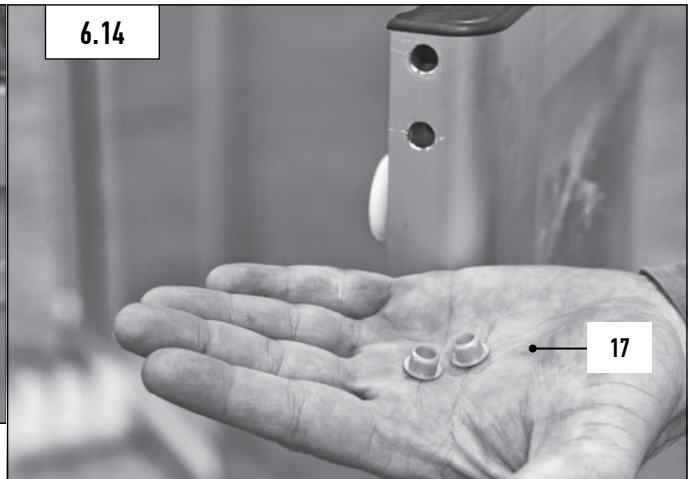

6 POSE DU JOINT – PORTE LATÉRALE COULISSANTE (JOINT INTÉRIEUR ET EXTÉRIEUR DE POLYCARBONATE PLEIN)

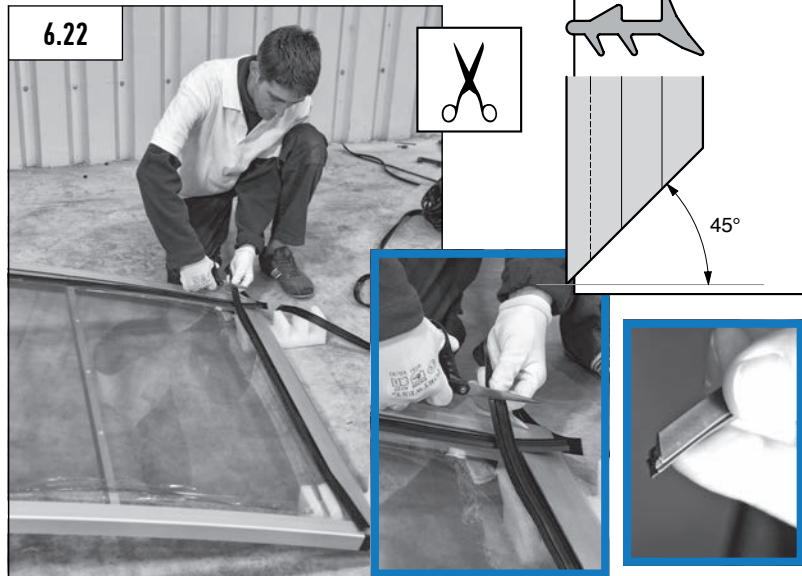
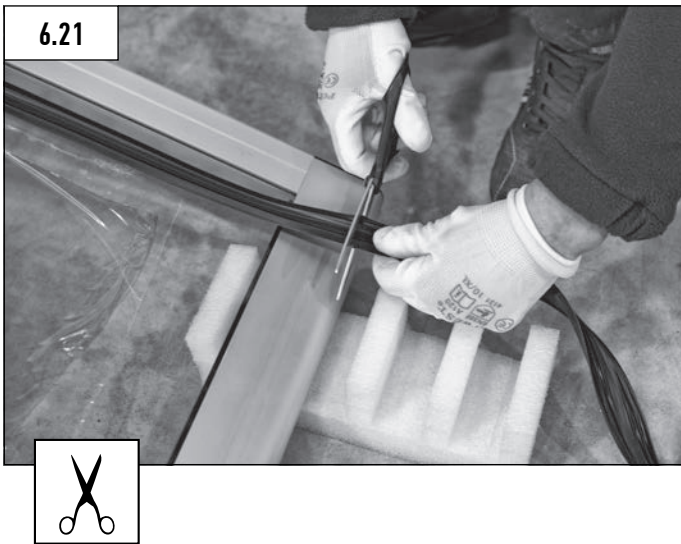
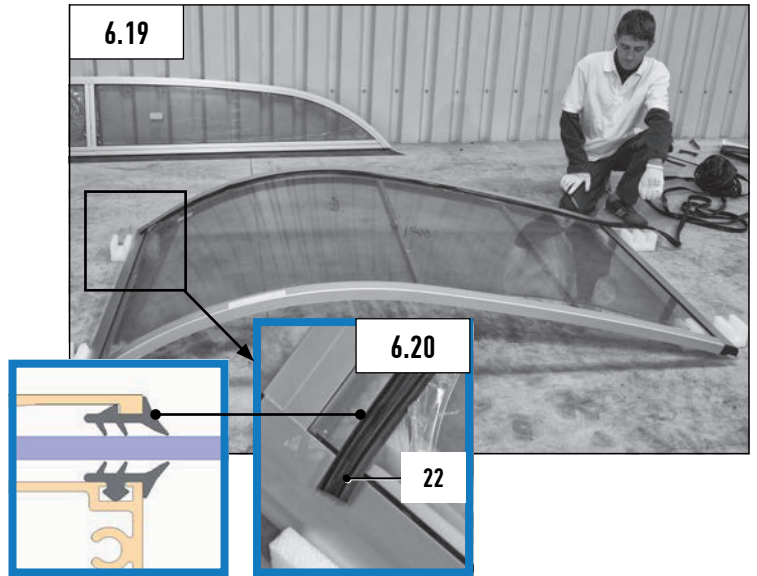
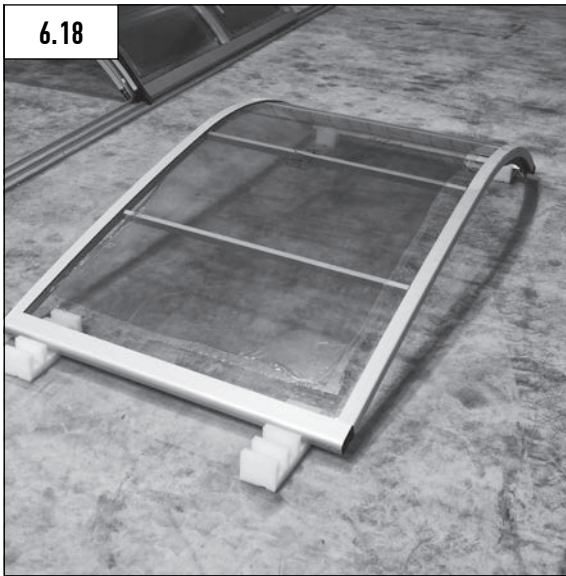

6 POSE DU JOINT – PORTE LATÉRALE COULISSANTE (JOINT INTÉRIEUR ET EXTÉRIEUR DE POLYCARBONATE PLEIN)

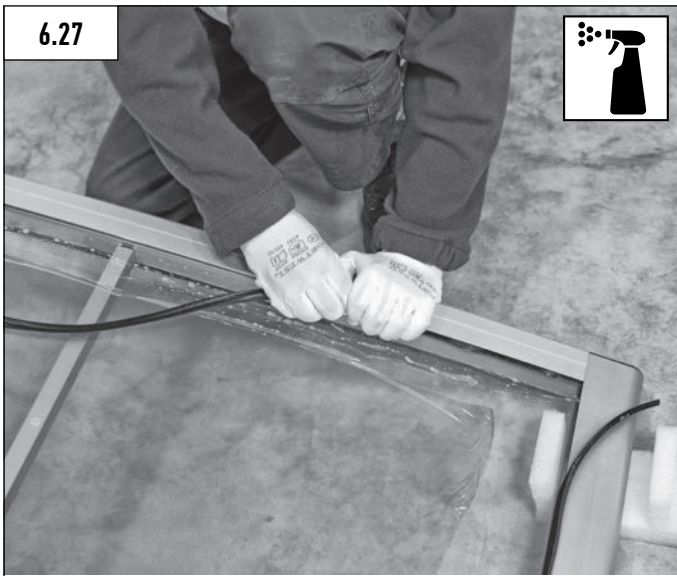
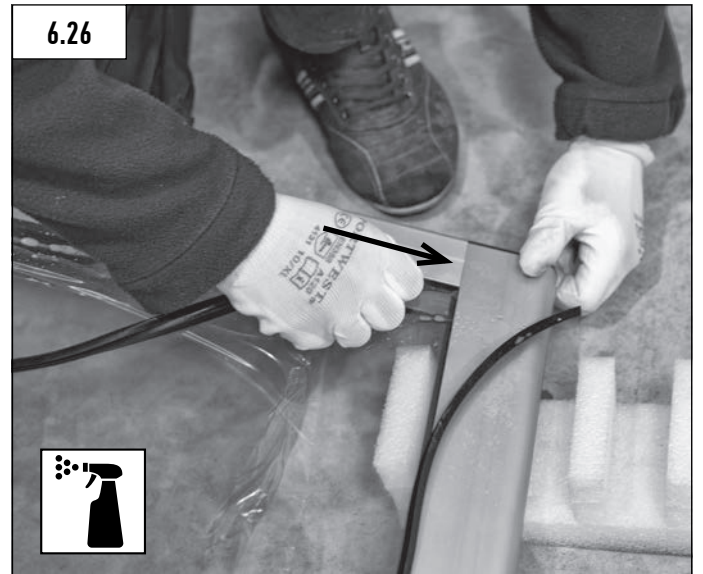
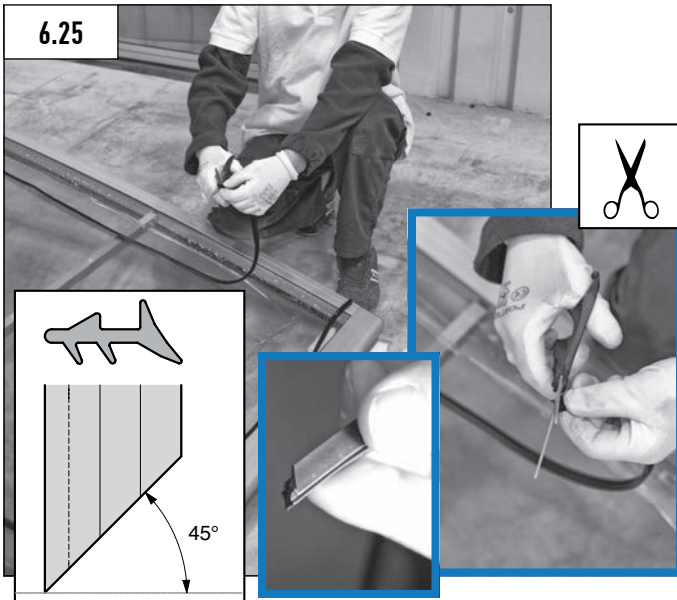

6 POSE DU JOINT – PORTE LATÉRALE COULISSANTE (JOINT INTÉRIEUR ET EXTÉRIEUR DE POLYCARBONATE PLEIN)

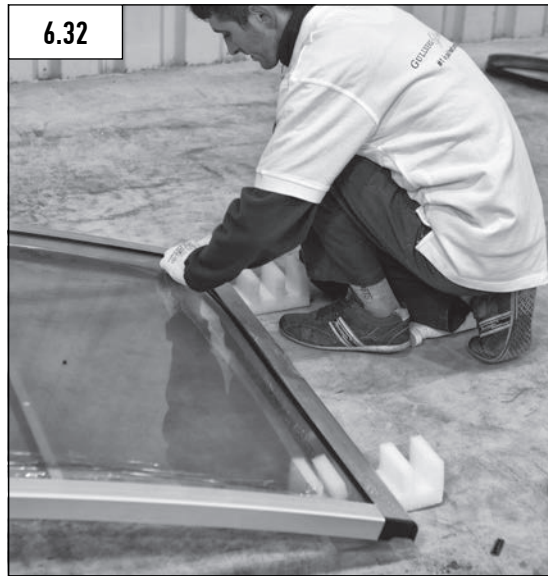

7 ENCLÈCHEMENT DES ÉLÉMENTS SUR PLATINES

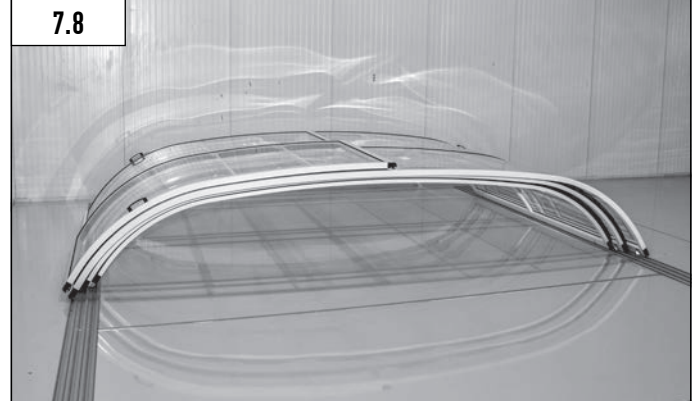
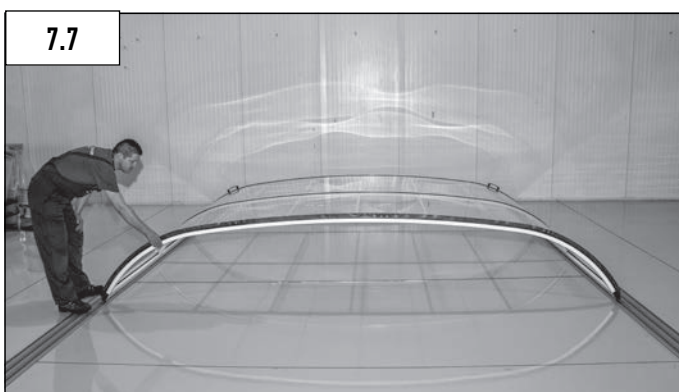
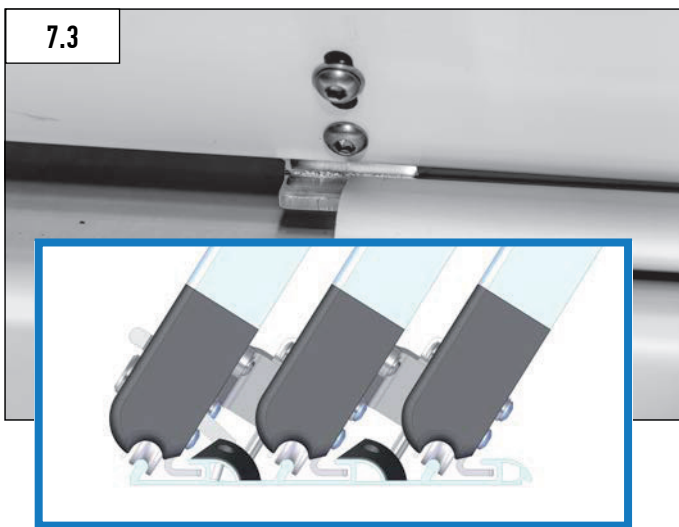
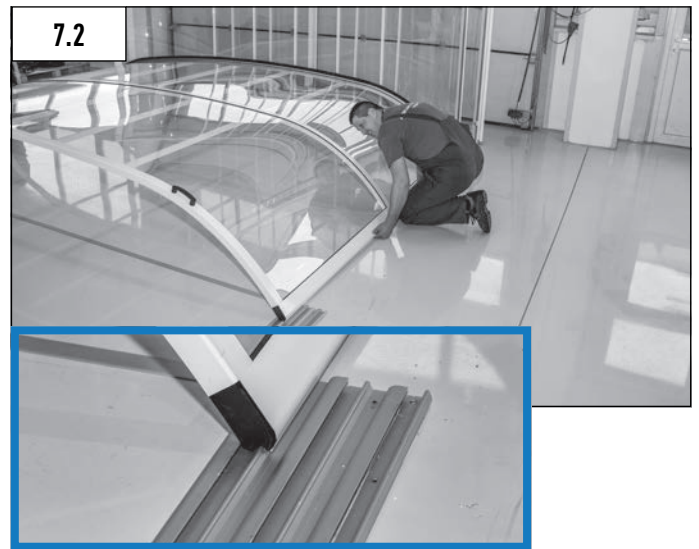



8

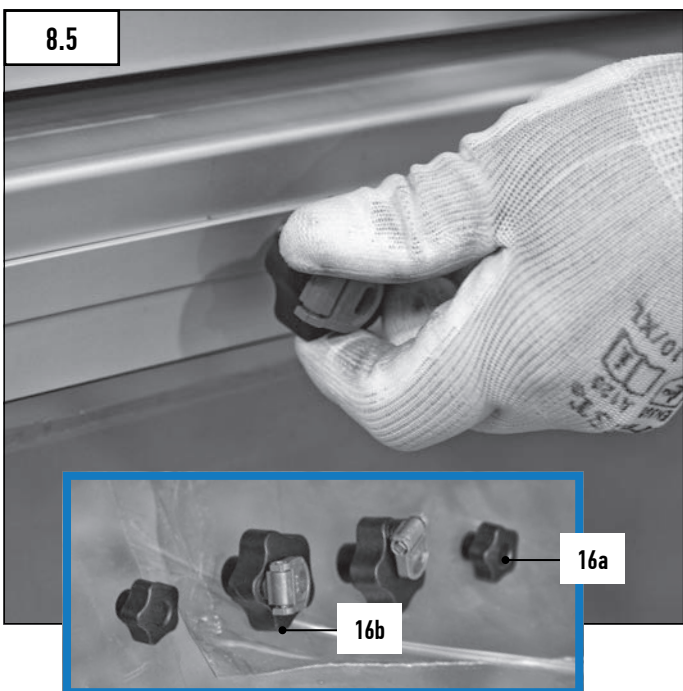
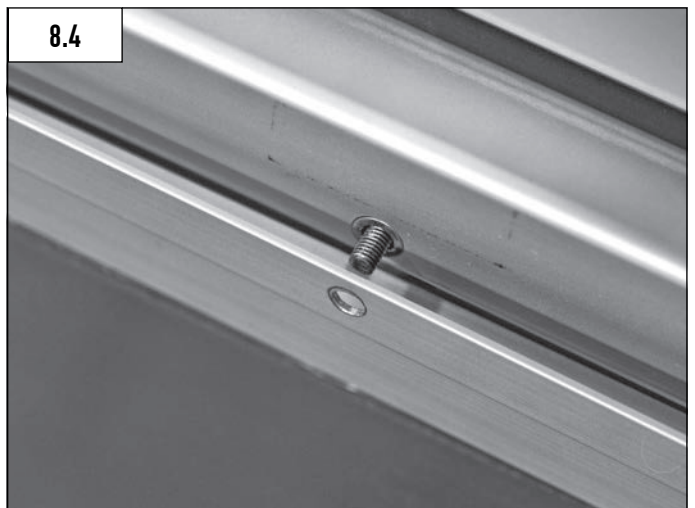

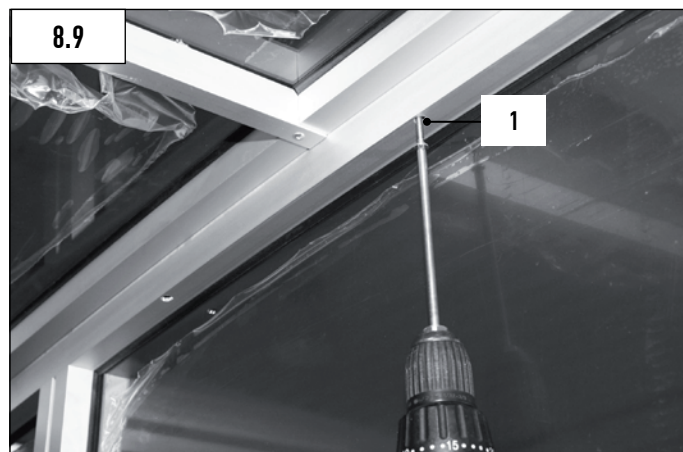

pour le modèle A5

**Visser graduellement en commençant du haut vers le bas
pour que la façade et le fond se mettent
en place sans forcer.**

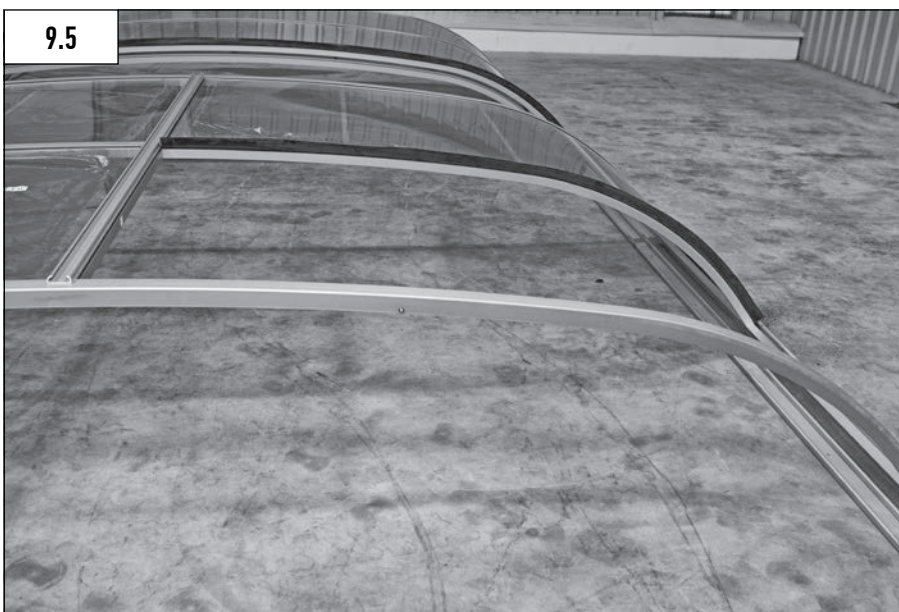
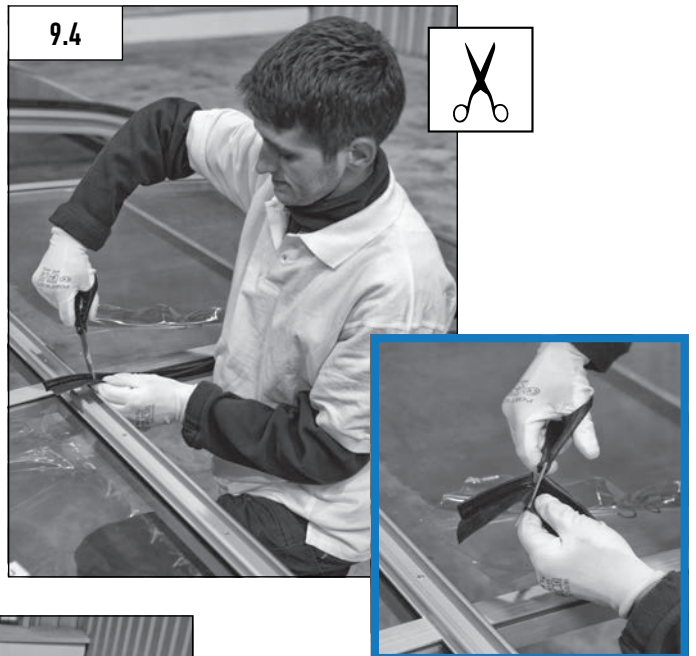
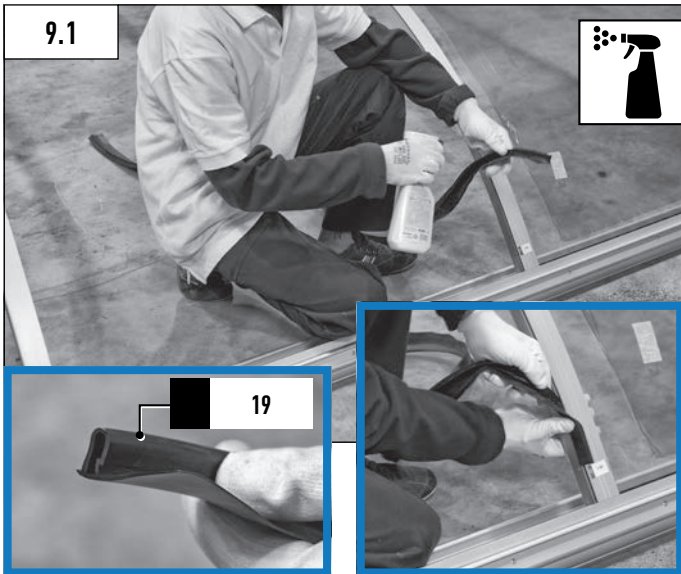

Avec des modèles A3 - A3/4 - A4 - A4/5

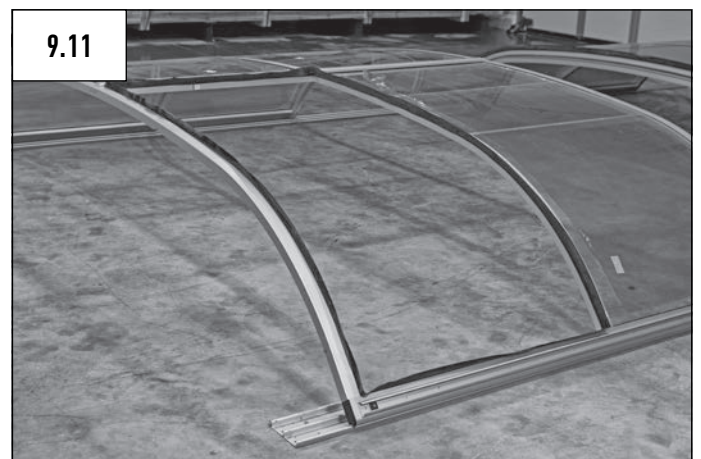
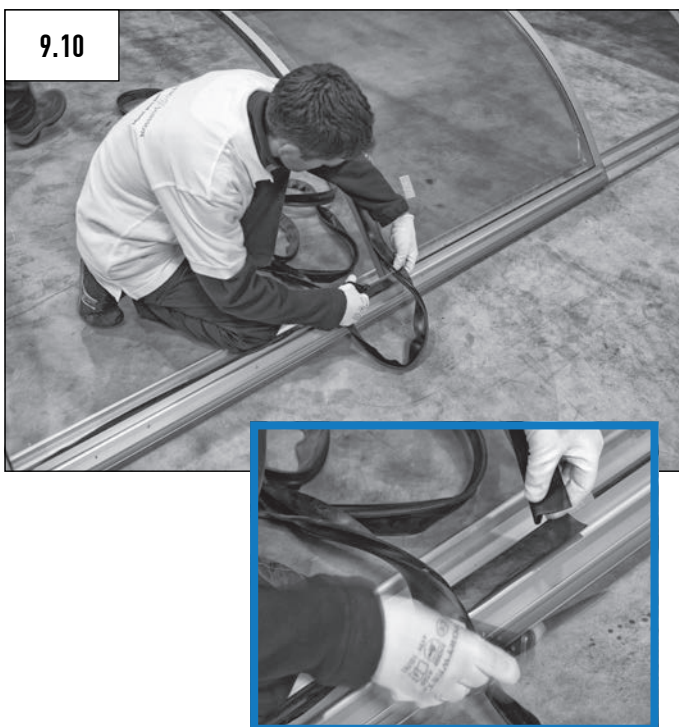
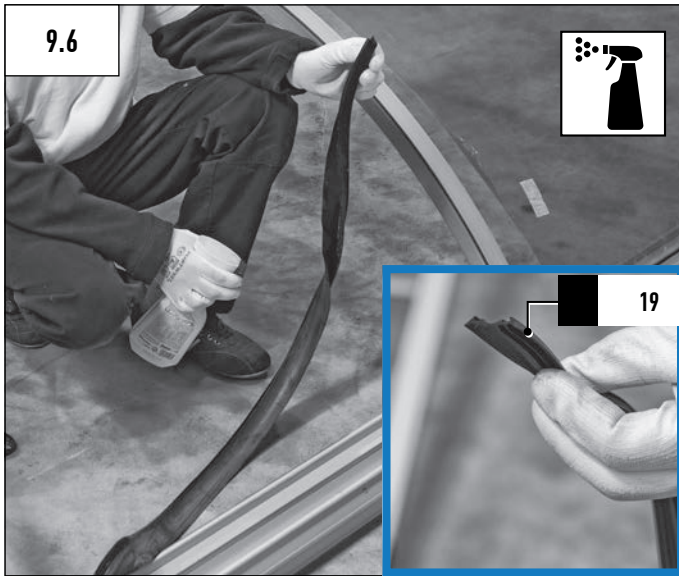

Avec modèle A5

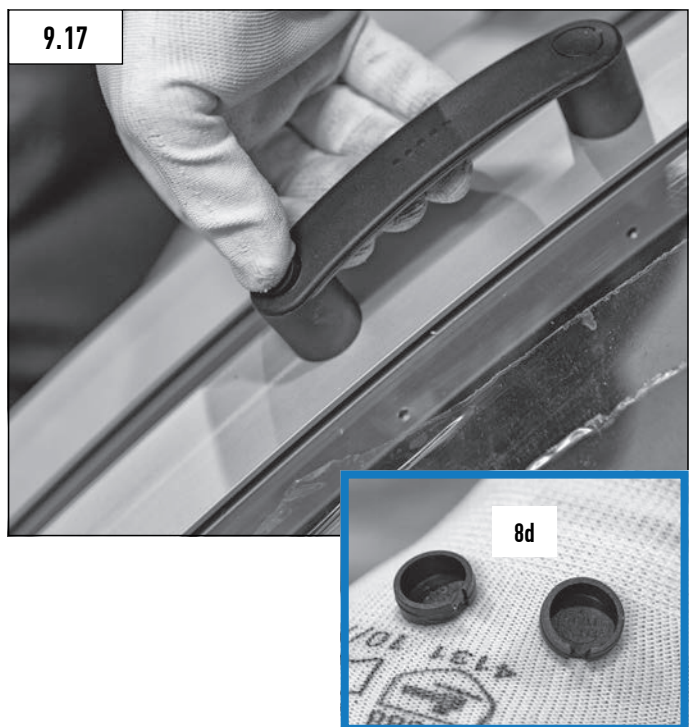
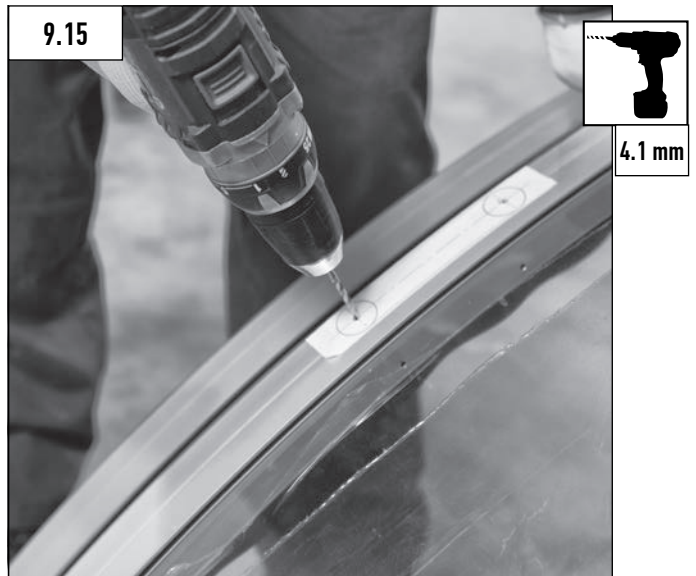
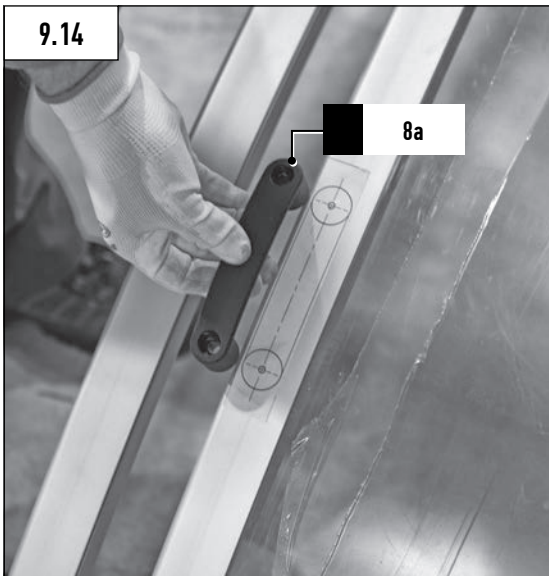
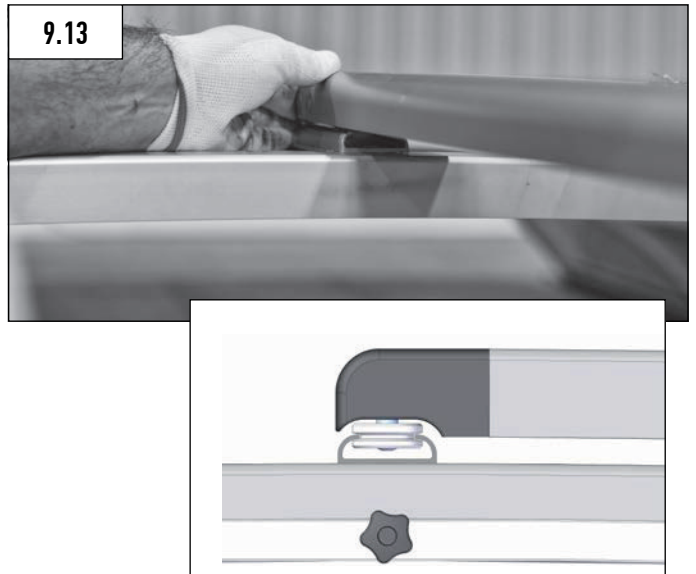

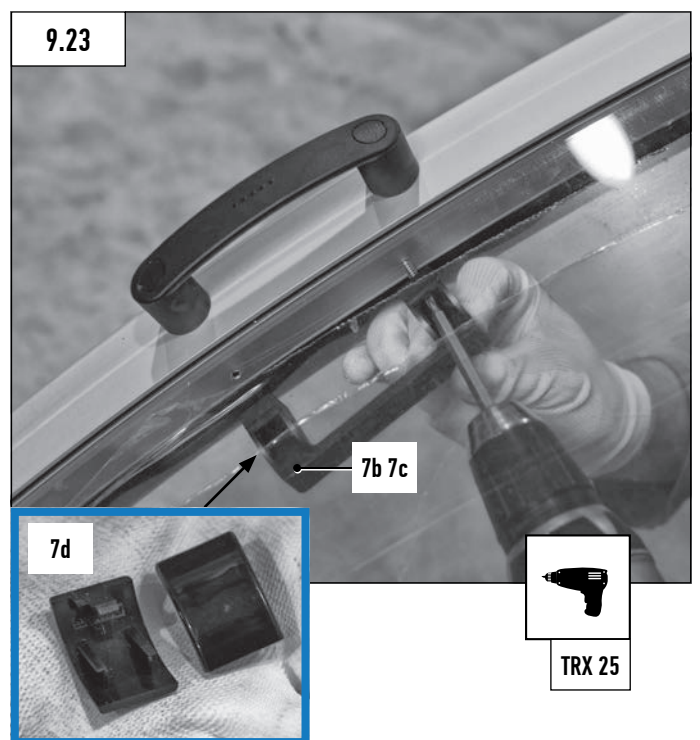
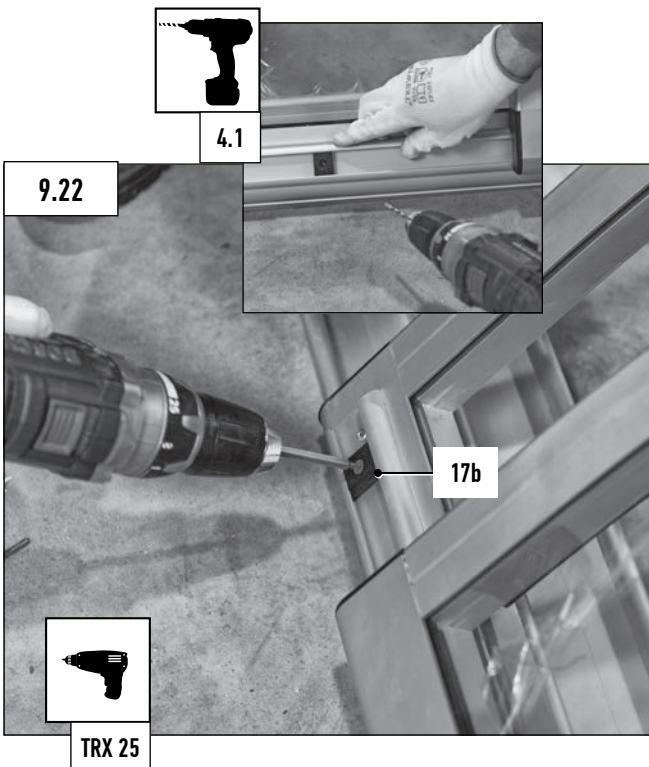
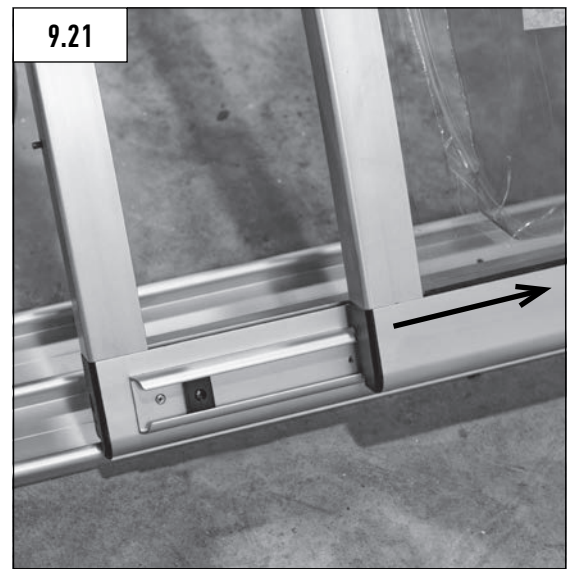
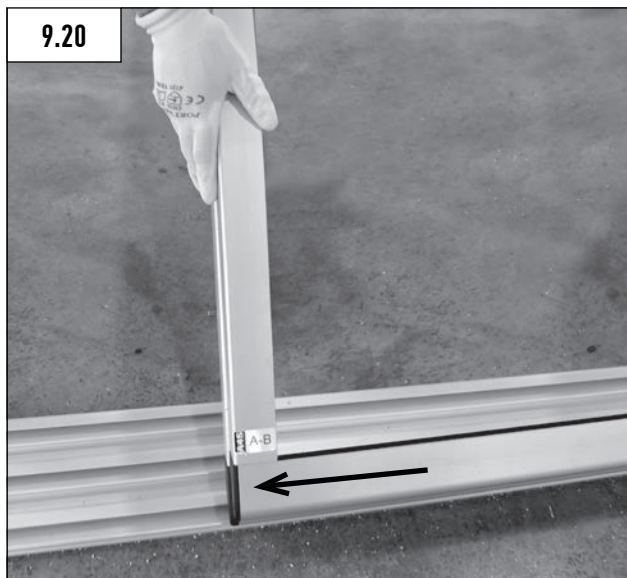
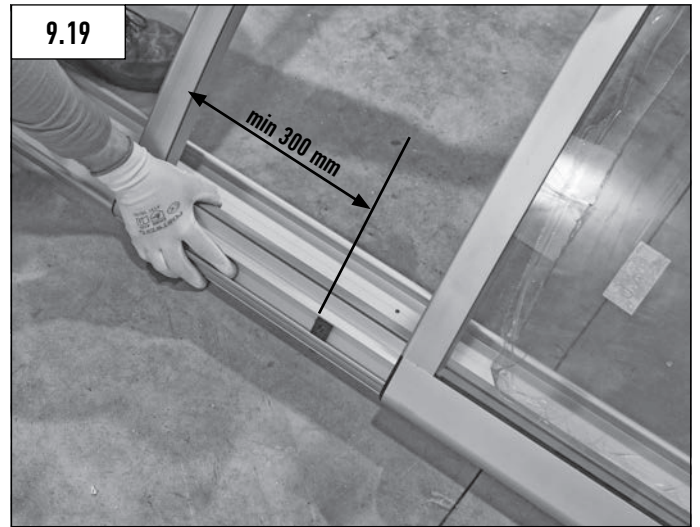
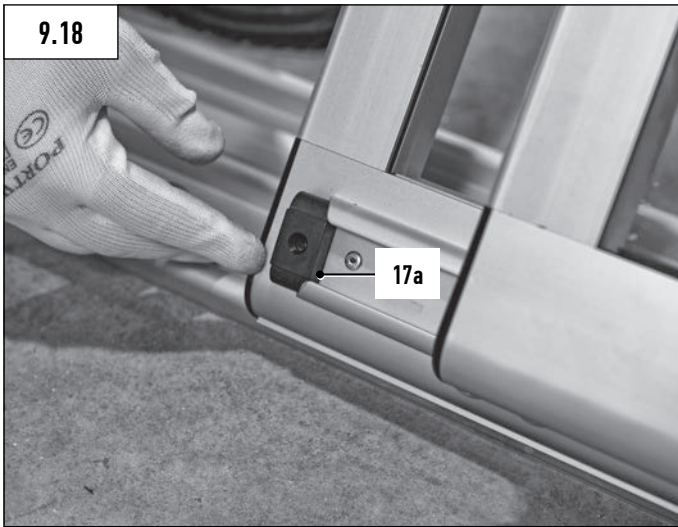

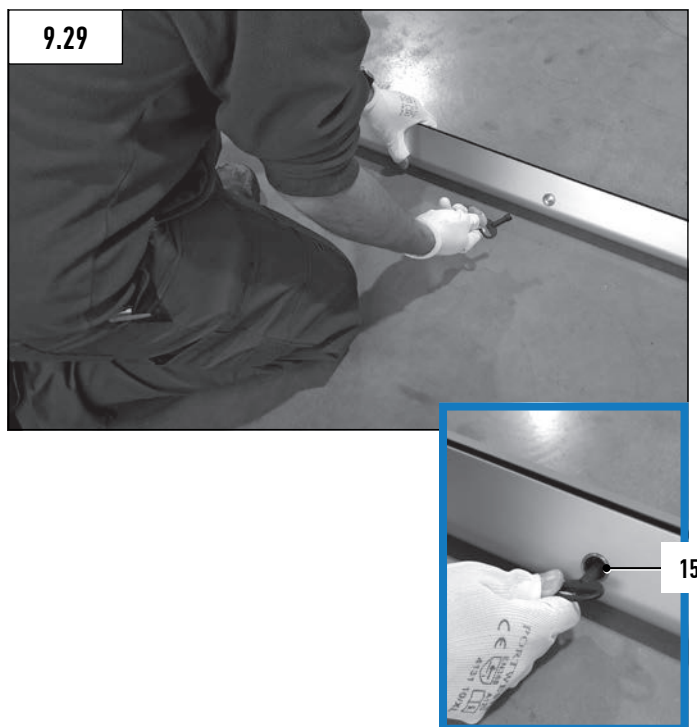
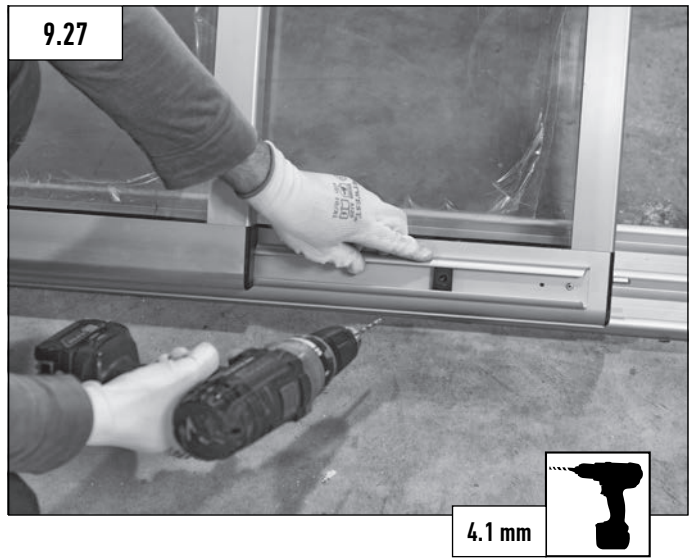
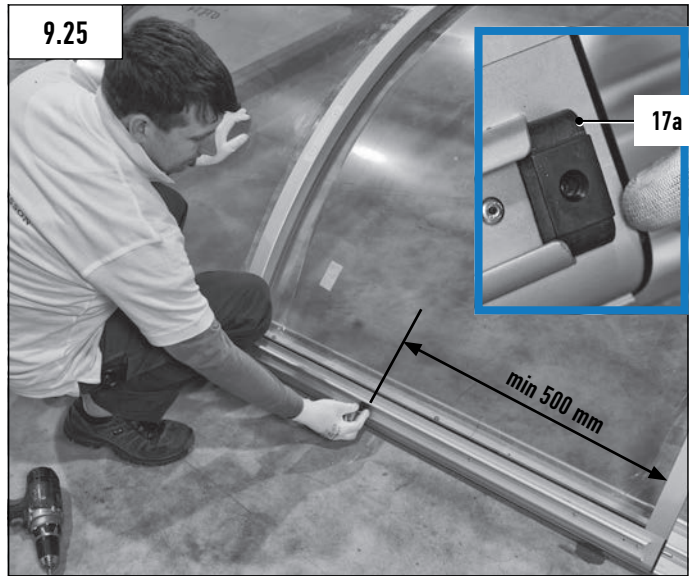

A4 A5

A3 A3/4 A4/5

no. article	dénomination	Pcs	Pcs	Pcs	Notes
14c	Embout sécurité	4	4	4	
14a	Jonction de platine	6	8 (16*(A4L))	10	
14b	Butée platine	6	8	10	1 d. + 1 g.
13	Douille verrou	2	2	2	

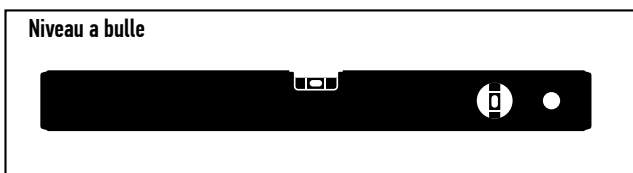
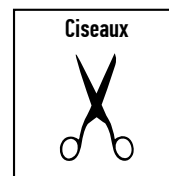
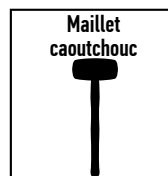
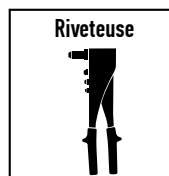
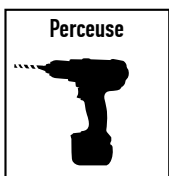

10 ASSEMBLAGE FINAL – POSITIONNEMENT DE VERROUILLAGE ET DES BUTÉES DE SÉCURITÉ!

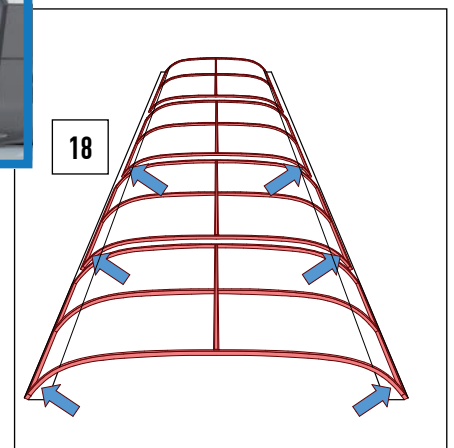
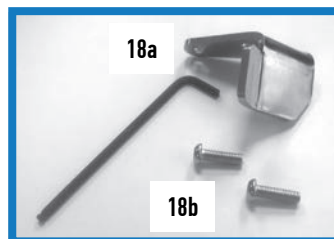
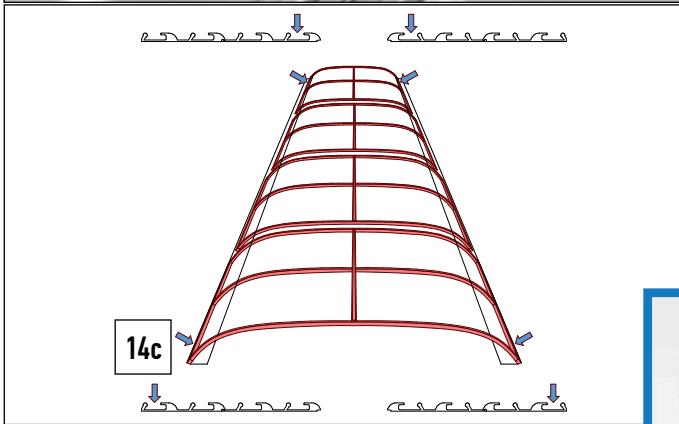
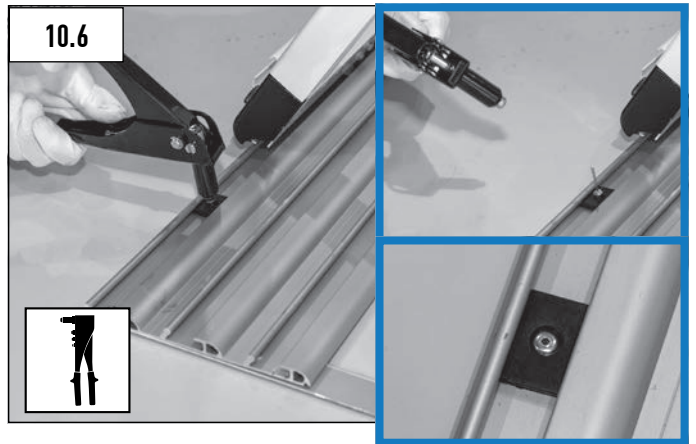
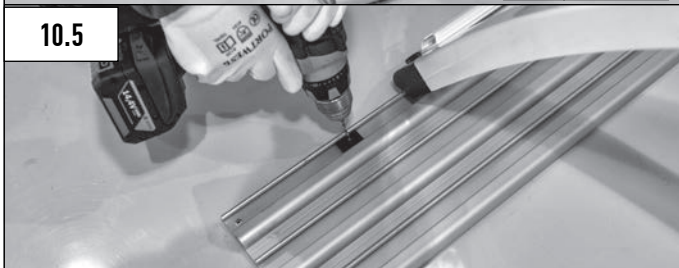
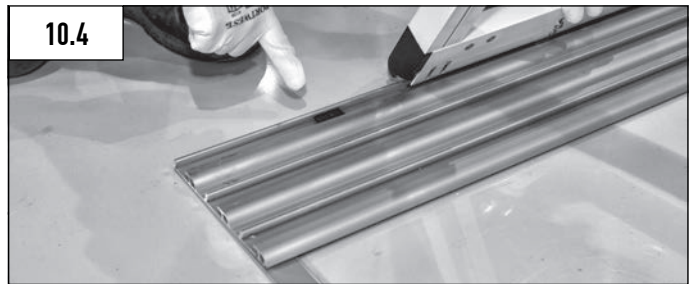
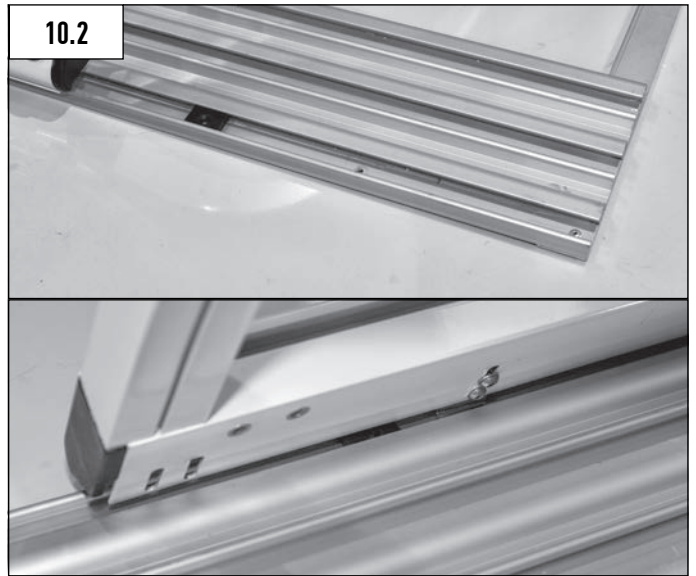
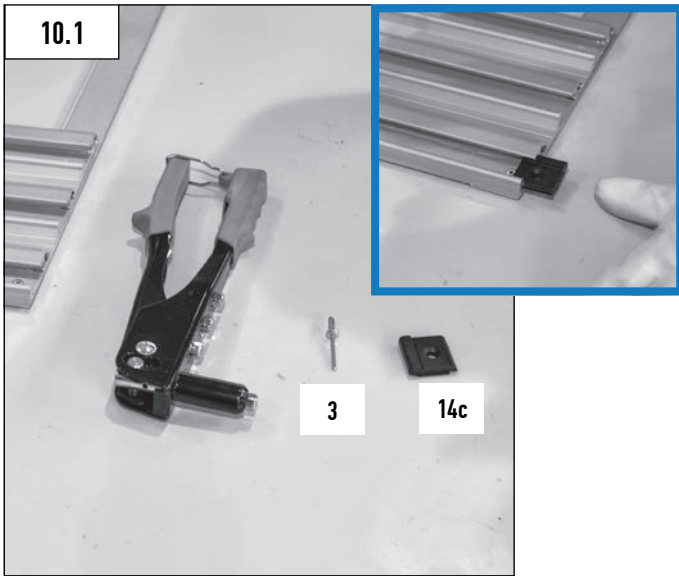

← Le front d'élément → L'arrière partie d'élément

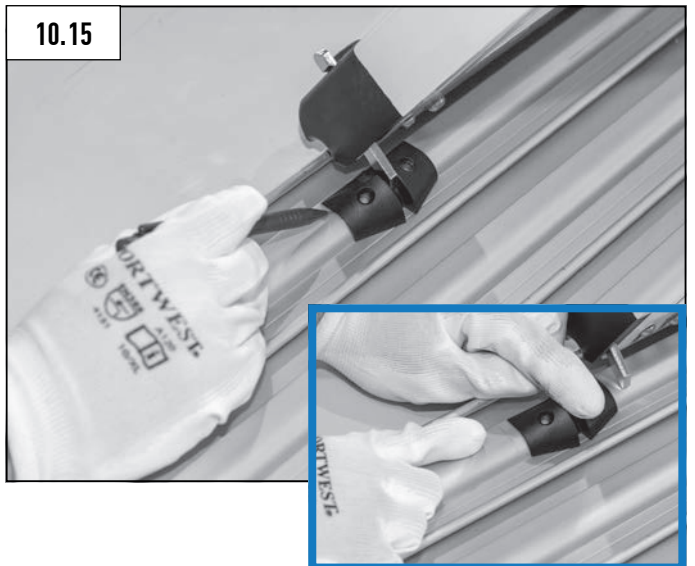
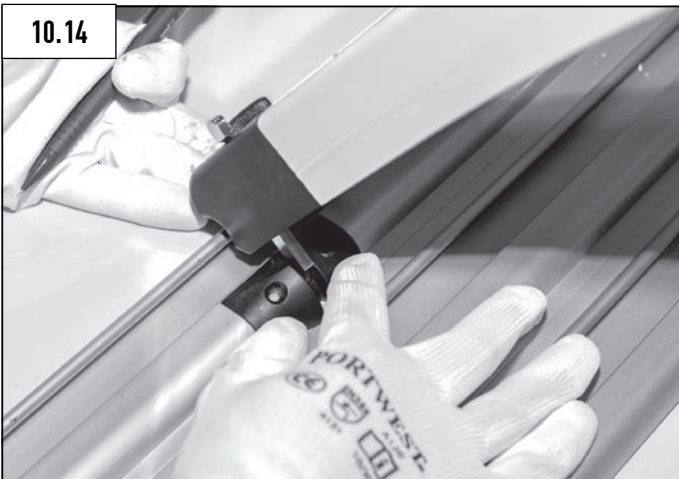
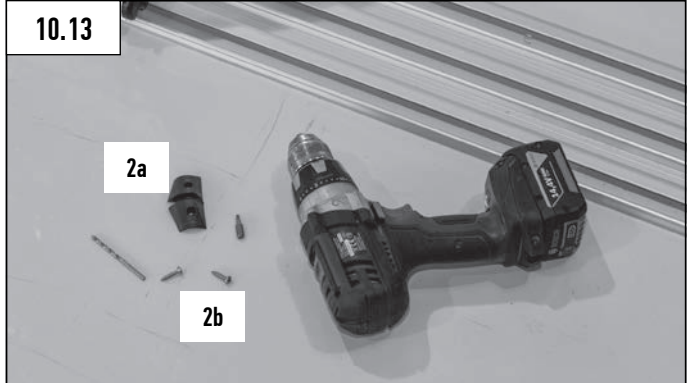
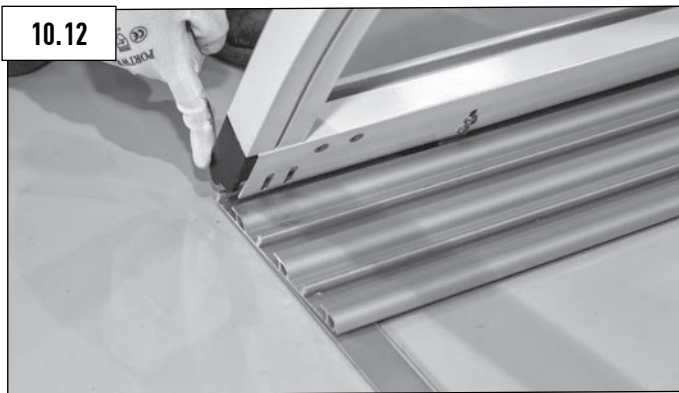
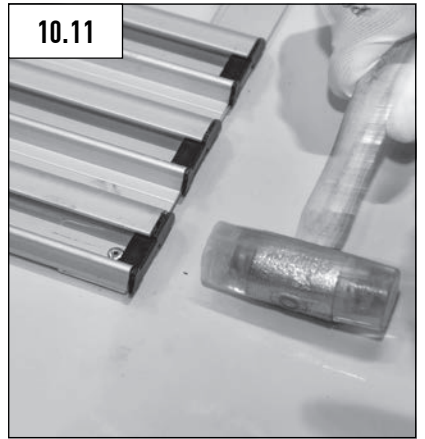
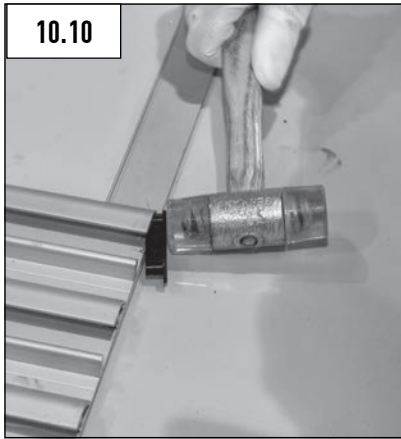
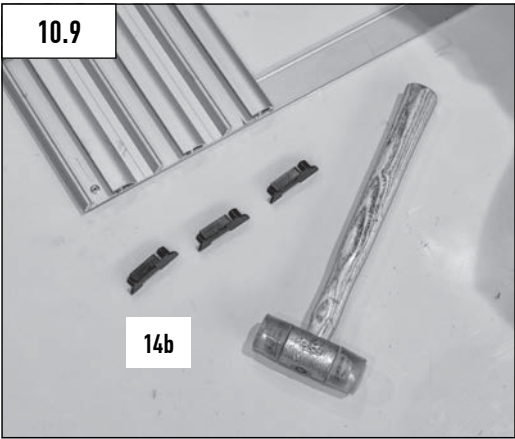
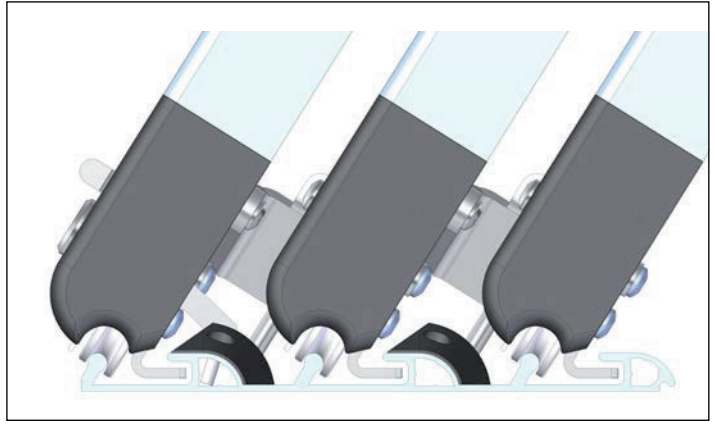

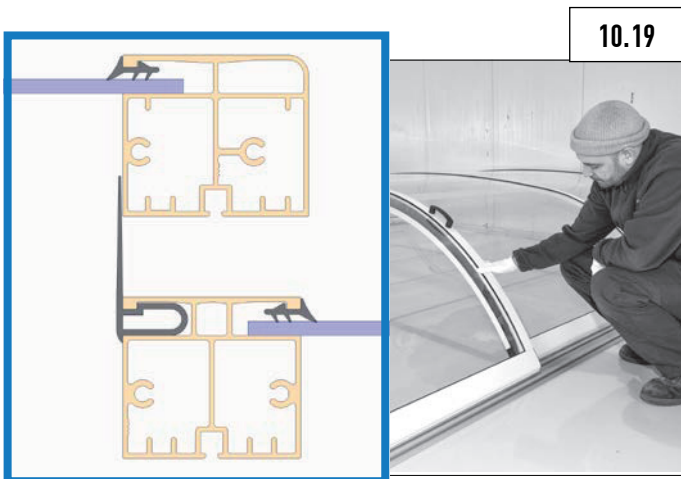
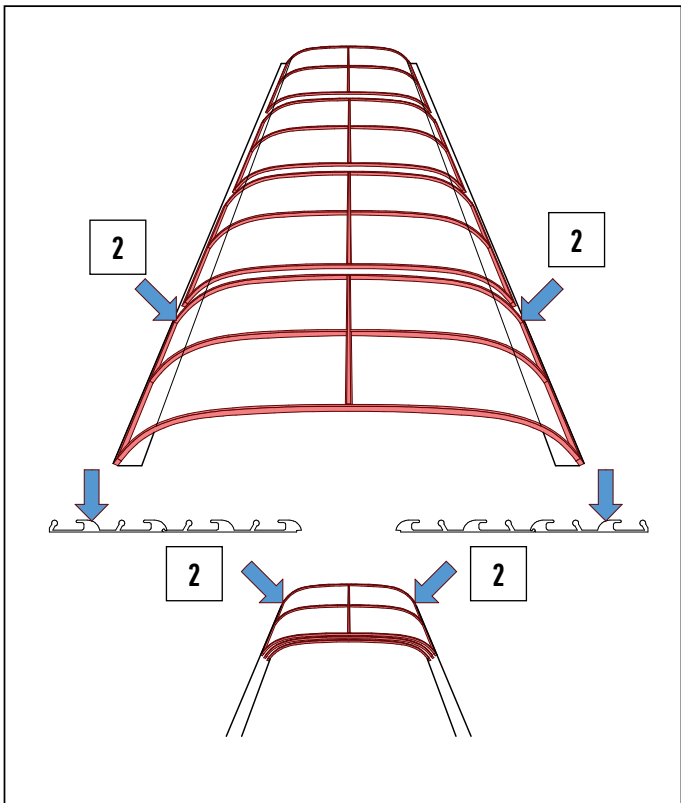
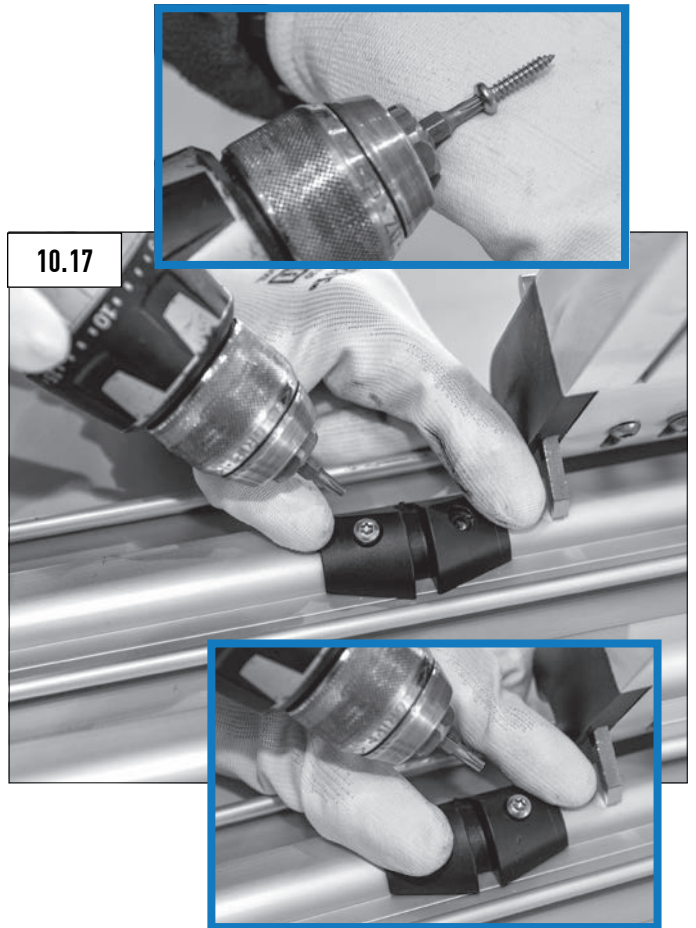

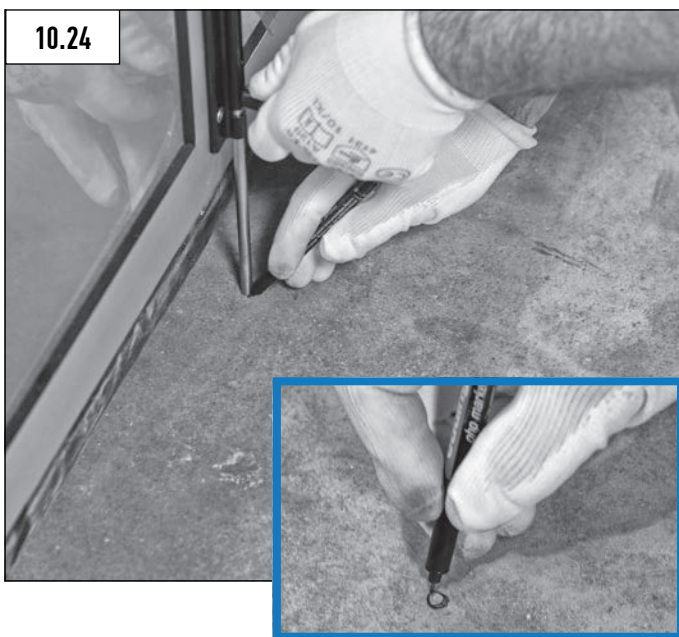
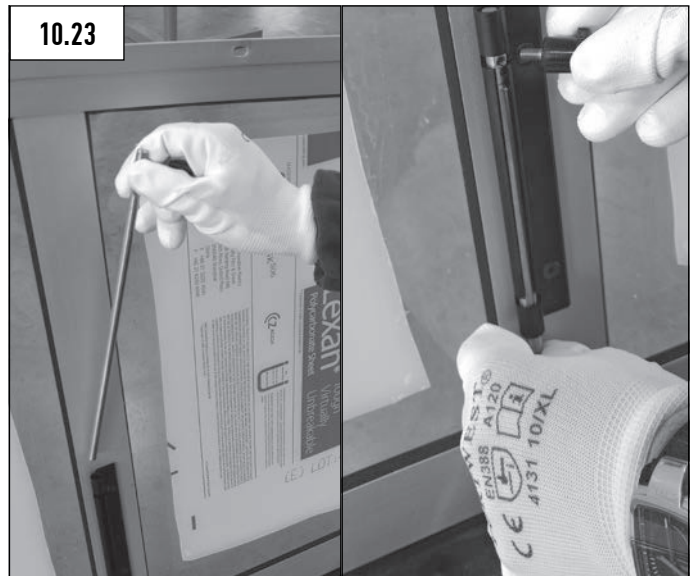
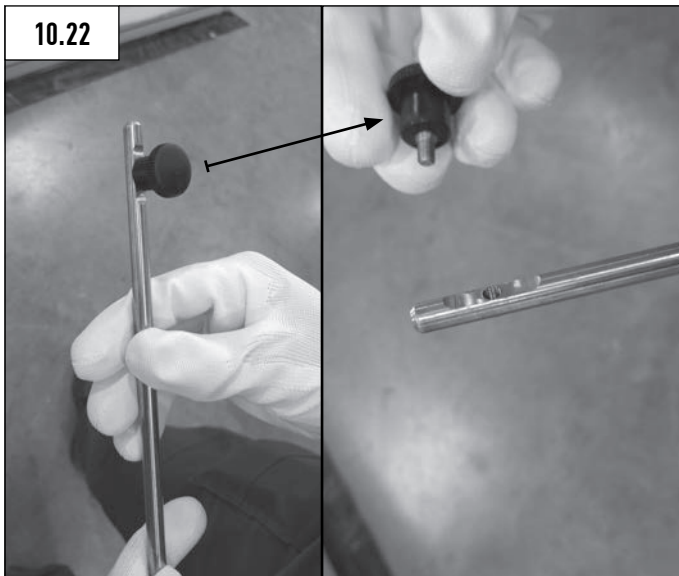
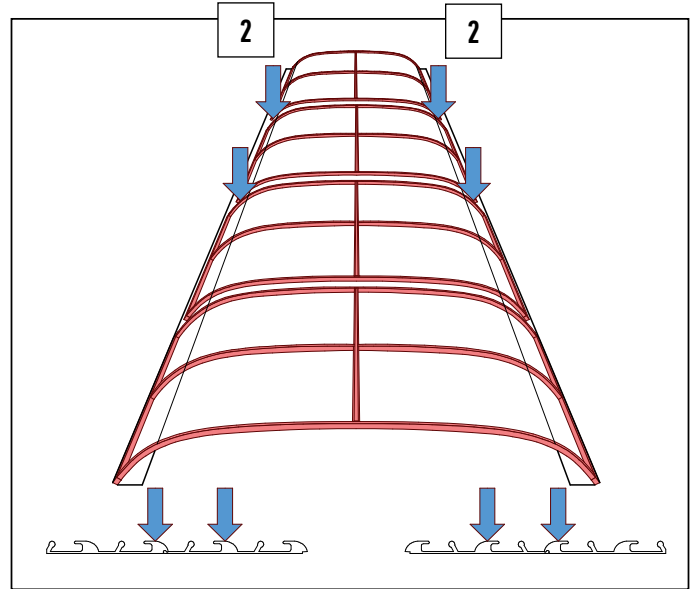

* MODÈLES BAS = FACADE ET FOND

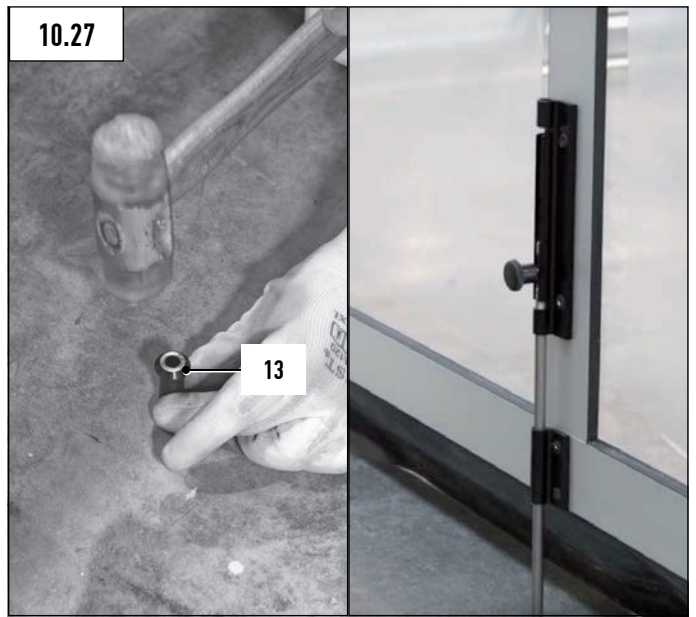
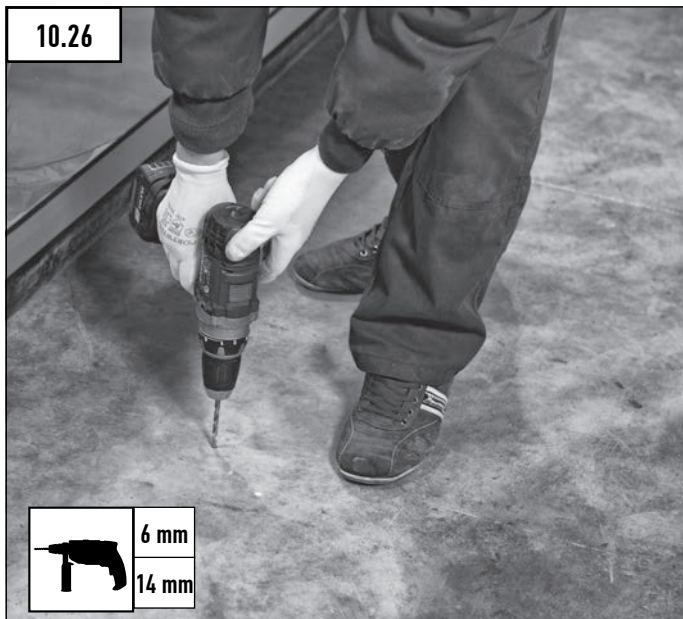

* MODÈLES BAS = FACADE ET FOND

ABRIS EN KIT

OPEN & SAFE

NOTICE DE MONTAGE

